

# My Descendant Chart

(1) Charles (ii) Boileau, 6G Grandfather (1673 - 1733)  
b. 1673 (1670?)  
d. 7 Mar 1733  
& Mary Magdalena Collot D'Escury, 6G Grandmother (1679 - 1731)  
b. 12 Nov 1679, France  
d. Sep 1731  
m. 30 Dec 1703, French Church of Saint Patrick, Dublin

(2) Marguerite (iv) Boileau, 6G Aunt (1710 - 1778)  
b. 20 Dec 1710 (1709?)  
d. 6 Jan 1778  
& Reverend John Peter Droz  
m. 22 Apr 1737

(3) Simeon Droz, 1C6R (1742 - )  
b. 1742  
& Frances Boutelle

(4) Maria Droz (1774 - )  
b. 1774  
& Colonel Thomas Hawkins

(5) Edward Simeon Hawkins ( - 1840)  
d. 1840  
& (5) Alicia Lumsden ( - 1828)  
d. 1828  
m. 1826

(6) Magdalen Sophia Hawkins

(5) Edward Simeon Hawkins ( - 1840)  
d. 1840  
& Eliza Goodwyn  
m. 1830

(6) Eliza Catherine Hawkins  
& (6) John Robert Ward ( - 1857)  
d. 1857  
m. 1850

(7) Emily Harriett Ward

(7) Grace Laura Ward

(7) John Henry Ward

(7) Henry Baynes Ward

(6) Edward Lindsay Hawkins  
& (6) Florence Mary Fisher  
m. 1866

(7) Florence Elizabeth Hawkins

(6) Henry Lumsden Hawkins

(5) Francis Spencer Hawkins ( - 1858)  
d. 1858  
& Maria Loveday  
m. 1823

(6) Mary Charlotte Hawkins  
& Dr. William Craddock ( - 1846)  
d. 1846

(7) Mary Bessie Craddock

(7) Unknown Craddock (1848 - )  
b. 1848

(7) William Francis Craddock (1831 - )  
b. 1831

(7) Edward Hawkins Craddock (1839 - )  
b. 1839

(7) Catherine Louisa Craddock

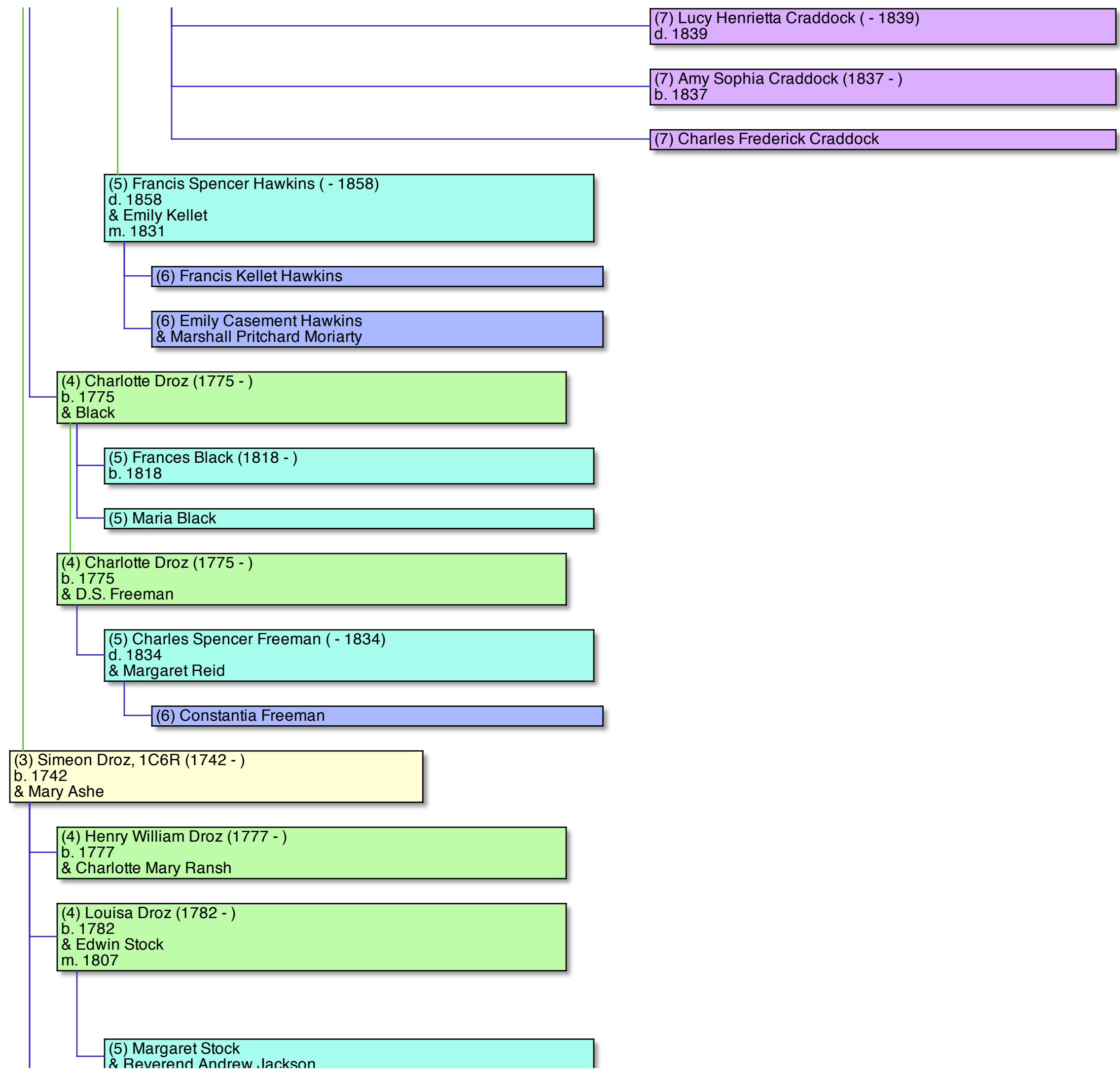

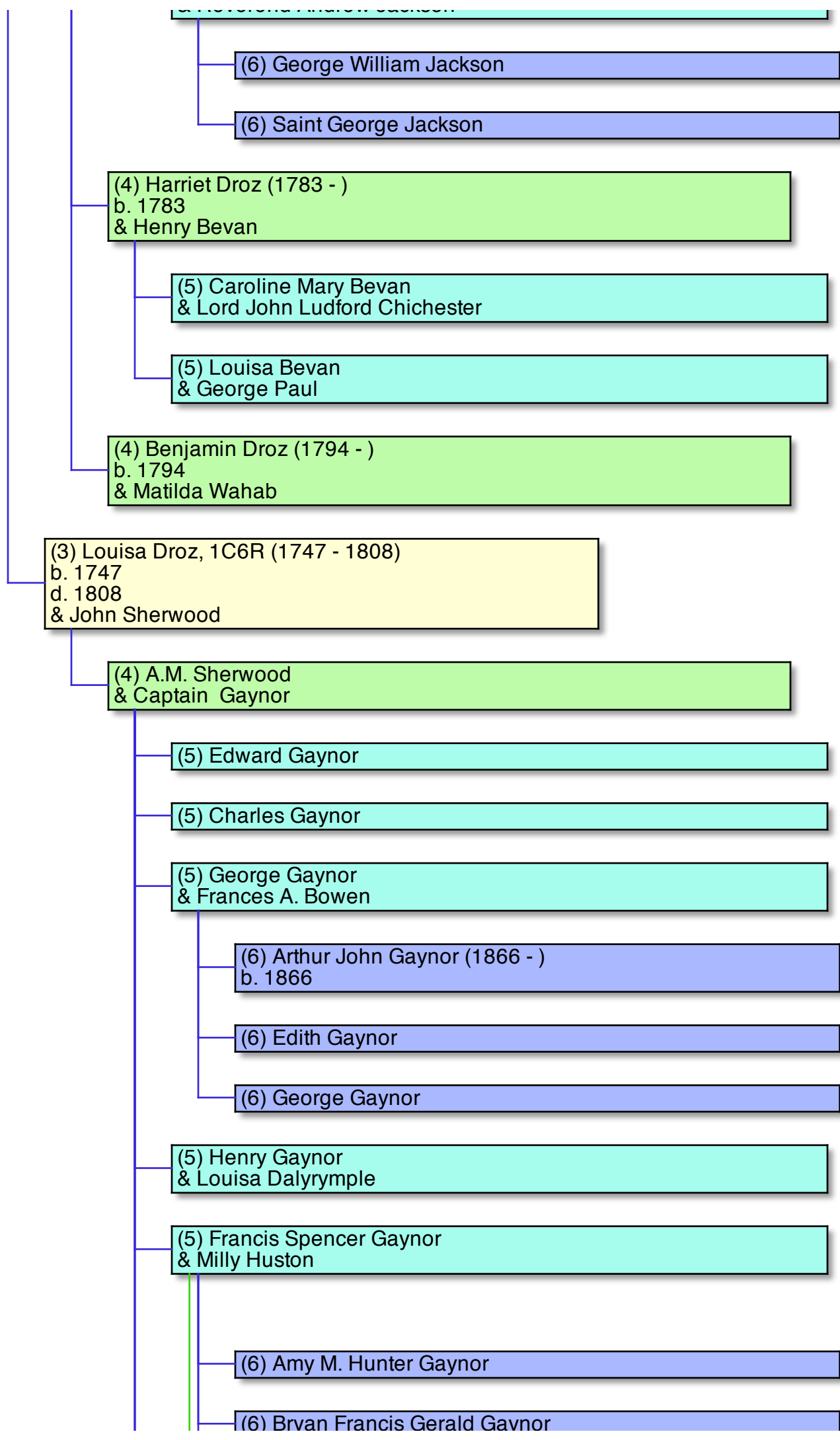

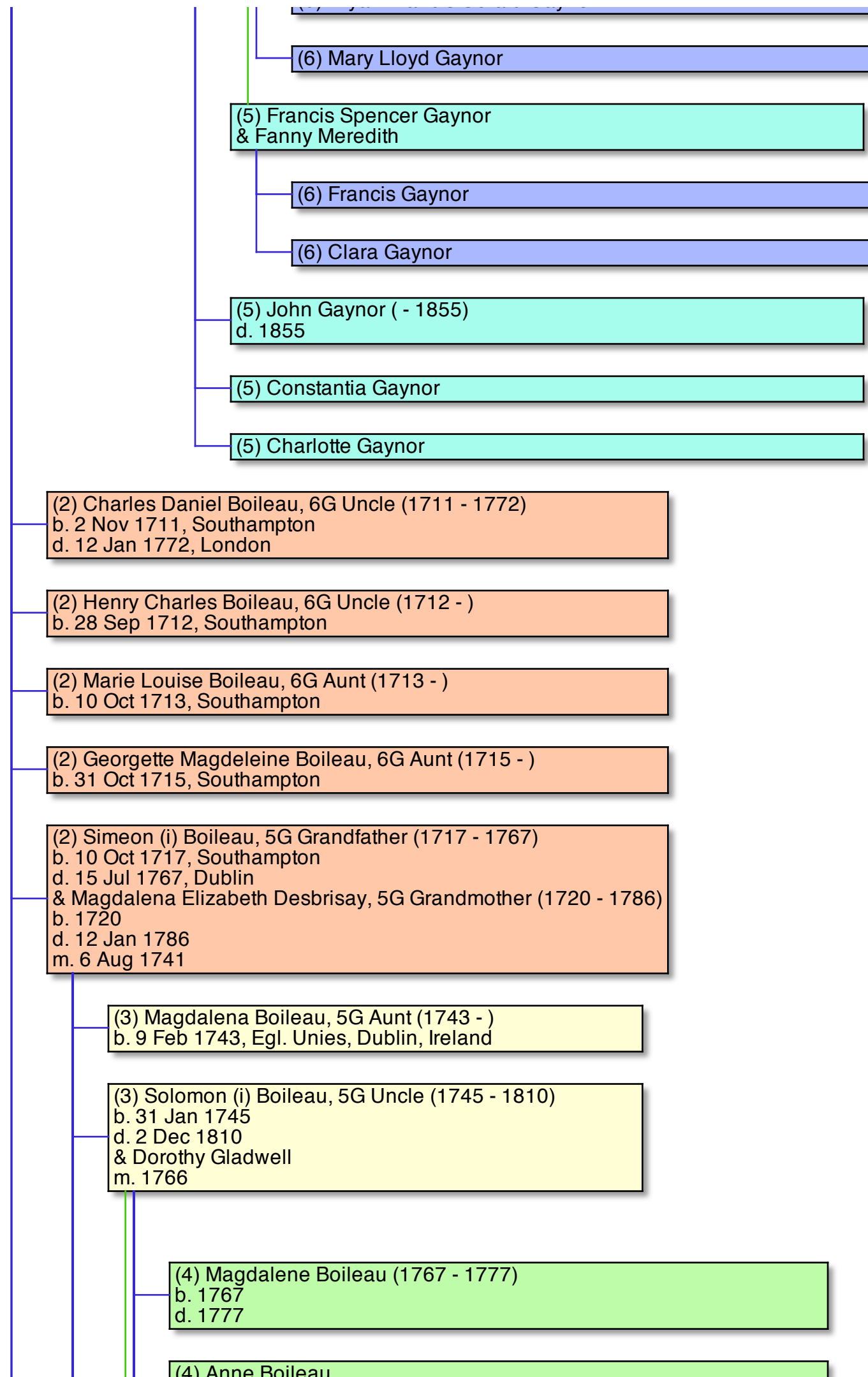

& Dr. John Reid  
m. 1791

(5) Henry Solomon Reid ( - 1852)  
d. 1852  
& Jane Caroline Blair  
m. 1822

(6) Reid  
& Eliza Anne Roles

(6) Blair Thomas Reid  
& Mary Tenant  
m. 1851

(6) Blair Thomas Reid  
& Harriet Learmonth  
m. 1865

(6) Anne Jane Reid (1831 - )  
b. 1831

(6) Henry Robert Reid  
& Margaret Harriet Ussher  
m. 1856

(7) Reid

(7) Henry Samuel Reid

(7) James Hales Reid

(6) George Morrison Reid ( - 1865)  
d. 1865  
& Emily Wilmot  
m. 1858

(7) Henry Allan Reid

(7) George Samuel Reid

(5) Henry Solomon Reid ( - 1852)  
d. 1852  
& Elizabeth Haggarty  
m. 1836

(6) John Lestock Reid

(6) Richard Lestock Holland Reid

(6) Anne Georgina Susan Reid

(5) Francis Charlotte Reid  
& George Mercer  
m. 12 Sep 1810

(6) Graeme Reid Mercer  
& Catherine Hay  
m. 1854

(6) Mercer ( - 1813)  
d. 1813

(6) George Duncan Mercer

(6) Anne Elliot Mercer  
& William Drummond Mercer  
m. 1853

(7) Anna Graeme Mercer

(7) William Lindsay Mercer

(6) Frances Georgina Mercer  
& George Falconer  
m. 1842

(7) John Stewart Falconer

(7) George Mercer Falconer

(7) William David Falconer

(7) Frances Henrietta Falconer

(7) Helen Jane Falconer

(7) Mary Georgina Falconer ( - 1851)  
d. 1851

(7) Falconer ( - 1852)  
d. 1852

(7) Charles Louis Currie Falconer

(7) Falconer ( - 1858)  
d. 1858

(6) Henrietta Jane Mercer

(6) William Thomas Mercer  
& Mary Phillips Nind  
m. 1862

(6) John Henry Mercer  
& Annie Catherine Anstruther  
m. 1861

(7) Laurence Mercer

(7) Frank Mercer

(7) Marion Maud Mercer

(6) Charles Mercer ( - 1826)  
d. 1826

(6) Charles MacWhirter Mercer

(6) Emily Eliza Mercer

(6) Louisa Rachel Mercer

(6) Laurence James Mercer

(6) Charlotte Catherine Mercer

(5) Harriet Anne Reid ( - 1853)  
d. 1853  
& Dr. John MacWhirter  
m. 12 Sep 1810

(6) John Lloyd MacWhirter ( - 1816)  
d. 1816

(6) Harriet Seton MacWhirter  
& Captain John Mackerlie  
m. ? 1839

(6) Anne Alicia Hare MacWhirter  
& Doctor John Learmonth  
m. 1837

(7) John Franklin Learmonth

(7) Harriet Learmonth  
& Blair Thomas Reid

(7) Thomas S. Learmonth

(7) Alicia McWhirter Learmonth

(7) Christian Learmonth



(7) Learmonth ( - 1846)  
d. 1846

(7) Elizabeth Reid Learmonth

(7) Anne Somerville Learmonth

(7) Arthur Cotton Learmonth

(7) Mary Georgina Learmonth

(6) Frances Mercer MacWhirter ( - 1820)  
d. 1820

(6) Jane Ricketts MacWhirter ( - 1820)  
d. 1820

(6) John Peach MacWhirter ( - 1857)  
d. 1857  
& Anne Harriet Clarkson  
m. 1846

(7) John Horatio MacWhirter

(7) Lester? Charles Harcourt MacWhirter

(7) James Mackillop MacWhirter

(7) Harriet Louisa Eliza MacWhirter

(7) Alfred Flemying Ross MacWhirter

(6) Flora Hastings MacWhirter  
& George A. Renny  
m. 1849

(7) Renny

(7) George Blakestone Renny

(7) Flora Harriet Renny

(7) Alexander McWhirter Renny

(7) Julianna Alice Renny

(7) Ellinor Tempest Renny

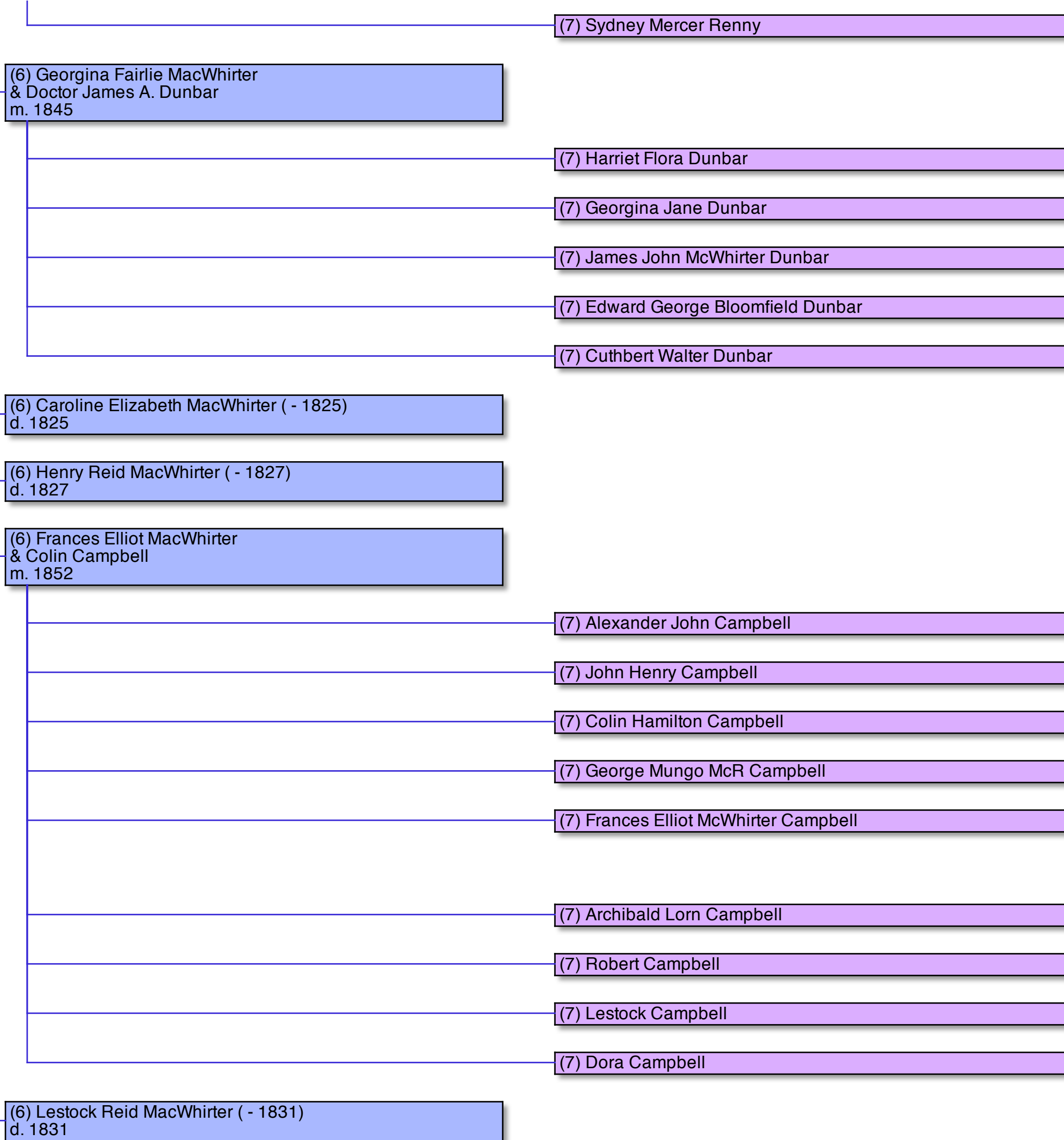

(6) Jane Abigail MacWhirter  
& Reverend Samuel Edward Bloomfield  
m. 1851

(7) Allan McWhirter Newham Bloomfield

(7) Edward Hugh Bloomfield

(7) Georgina Elizabeth Bloomfield

(7) Alicia Jean Bloomfield

(7) Frances Hart? Eardley Bloomfield

(6) Adelaide Clementia MacWhirter ( - 1838)  
d. 1838

(6) Margaret Elizabeth MacWhirter ( - 1845)  
d. 1845

(5) Sarah Dorothy Reid ( - 1795)  
d. 1795

(5) John Flemming Reid ( - 1797)  
d. 1797

(5) John Flemming Martin Reid ( - 1859)  
d. 1859  
& Jane Elizabeth Stewart

(6) John Stewart Reid ( - 1824)  
d. 1824

(6) Henry Stewart Reid  
& Mary Alexina Eckford  
m. 1847

(7) Mary Jane Stewart Reid

(7) Henry Philip Stewart Reid

(7) Arthur Hay Stewart Reid

(7) Ethel Thornhill Stewart Reid

(7) Herbert Astell Stewart Reid

(6) Reid ( - 1828)  
d. 1828

(6) Elizabeth Anne Reid  
& Charles Trevor Wheler  
m. 1861

(7) Edith Trevor Wheler

(7) Gertrude Trevor Wheler

(7) Maud Trevor Wheler

(6) Jane Eleonora Reid  
& William White  
m. 1865

(6) Harriette May Reid (- 1849)  
d. 1849

(6) John William Reid  
& Alice Georgina Onslow  
m. 1861

(7) Elizabeth Laura Reid

(6) Clementina Louisa Reid

(6) Reid (- 1838)  
d. 1838

(5) Elizabeth Reid (- 1798)  
d. 1798

(5) Lestock Robert Reid M.C.S.  
& Emily Rogers

(6) Lestock Reid  
& Sarah Emily Eastwick  
m. 1851

(7) Emily Martha Reid

(7) Lestock Eastwick Reid (- ?1851)  
d. ? 1851

(7) William Erskine Reid

(6) Emily Georgina Reid  
& Claudius James Erskine  
m. 1847

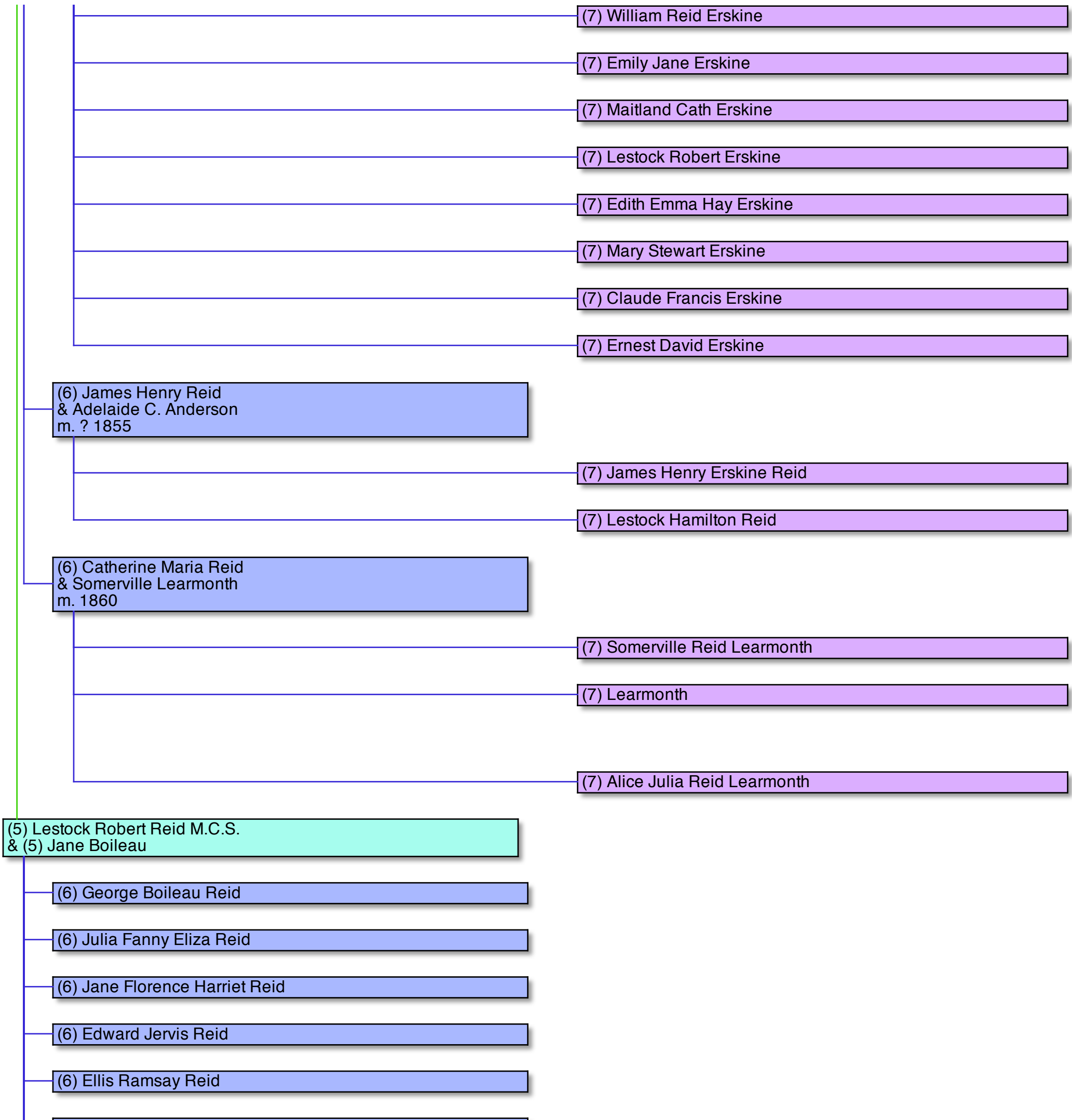

- (6) William Crawford Reid
- (6) Frank Lumsden Reid
- (6) Claude Gordon Reid
- (6) Arthur Morse Reid
- (6) Ada Ruth Erskine Reid
- (6) Percy Firth Reid
- (6) Ethel Emma Louisa Reid
- (6) Mary Rachel Reid

(5) Charles Samuel Reid & Catherine Cecilia Durie

- (6) Anne Jane Reid
- (6) Charles George Reid ( - 1855)  
d. 1855
- (6) William Bannatyne Reid ( - 1857)  
d. 1857
- (6) John Reid ( - 1840)  
d. 1840
- (6) Katharine Louisa Reid
- (6) Lestock Durie Reid
- (6) Frances Eliza Blair Reid
- (6) Mary Ellen Reid
- (6) Henry John Glennie Reid

(5) George William Edmondstone Reid ( - 1811)  
d. 1811

(4) Dorothea Boileau (1768 - 1770)  
b. 1768  
d. 1770

(4) Frances Boileau (1771 - 1852)  
b. 1771  
d. 1852

& John Chauvette  
m. 1791

(4) Frances Boileau (1771 - 1852)  
b. 1771  
d. 1852  
& Abraham Franco  
m. 1796

(5) Franco ( - 1797)  
d. 1797

(5) George Flemming Franco  
& Eliza Fagan

(5) Abraham Francis Franco ( - 1821)  
d. 1821

(4) Simeon Peter Boileau (1772 - 1842)  
b. 1772  
d. 1842  
& Hannah Ripton  
m. 1796

(5) Lucinda Florence Boileau ( - 1837)  
d. 1837  
& Martin Thomas Whish  
m. 1816

(6) Martin Boileau Whish  
& Emily Jane Ripton Turner

(6) Charles William Francis Whish  
& Harriet Louise Fisher  
m. 1832

(7) Lucy Eleonora Whish

(7) Florence Rosa Whish

(6) Harriet M. Benyan Whish  
& George Mytton Hill  
m. 1841

(7) Emma Monteath Hill  
& L. M. Moens?

(7) Hill

(7) George Mitchell Devraux Hill

(7) Roland Mytton Hill

(7) Lucy Anne Hill  
& G.M. Bowie

(7) Harriet Alice Hill

(7) Jessie Isabel Hill

(7) Arthur Hill

(7) Martin McKinnon Hill

(7) Florence Augusta Hill

(6) Henry Bedonvoir Whish ( - 1819)  
d. 1819

(6) Alicia Maria Whish  
& Alexander Cunningham  
m. 1840

(7) J.C. Allan Cunningham ( - 1842)  
d. 1842

(7) Alicia? F.D. Cunningham

(6) Fanny Whish ( - 1825)  
d. 1825

(5) Lucinda Florence Boileau ( - 1837)  
d. 1837  
& Colonel Thomas Monteath

(6) Archibald Douglas Monteath ( - 1853)  
d. 1853

(6) Amelia Murray Monteath  
& Captain William Scott  
m. 1861

(6) Augusta Emmeline Monteath  
& Reginald Yorke  
m. 1862

(5) Dorothy Ellen Boileau  
& Thomas King  
m. 1814

(6) Hannah Maria King ( - 1815)  
d. 1815



(6) Elizabeth King  
& Charles Rockford Mayne

(7) Thomas Mayne

(7) Harriet Elizabeth Mayne

(7) Alicia Ellen Mayne

(7) Bessy Mayne

(6) Benjamin Samuel King  
& Alicia Maline

(7) Thomas Fraser King

(6) Maria Ellen King  
& George Workman

(7) Georgina Workman

(7) Richard Carleton Workman

(6) Lucy Eliza King ( - 1843)  
d. 1843

(6) William Lestock King  
& Sarah Short

(7) Mary Lestock King

(6) Anne King  
& James King

(7) William King

(7) Gertrude Ellen King

(7) Eliza Fraser King

(6) Thomas King ( - 1843)  
d. 1843

(6) Gertrude Ellen King  
& Reverend Charles Yoe

(6) Henry King  
& Grace Matheson

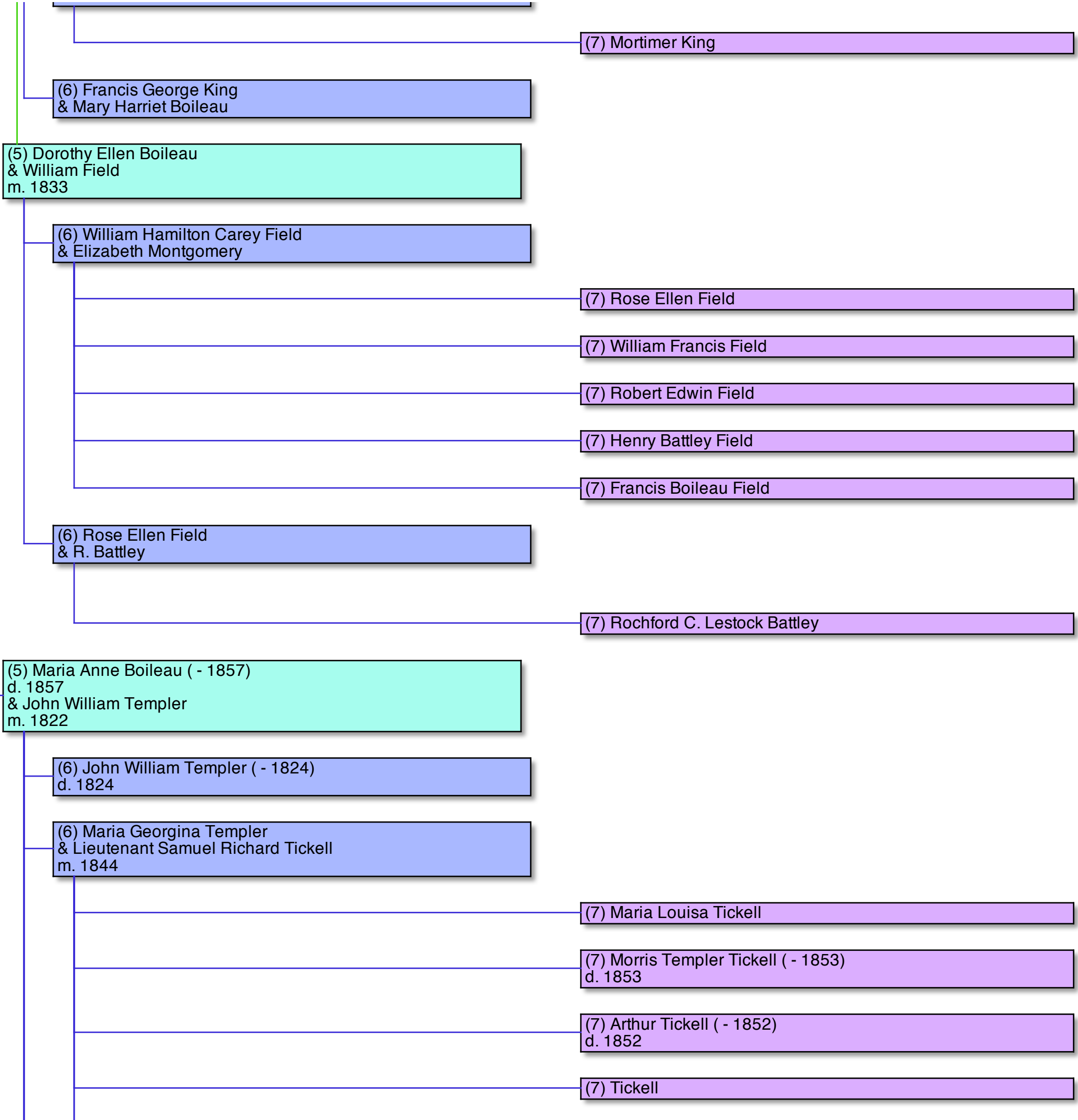

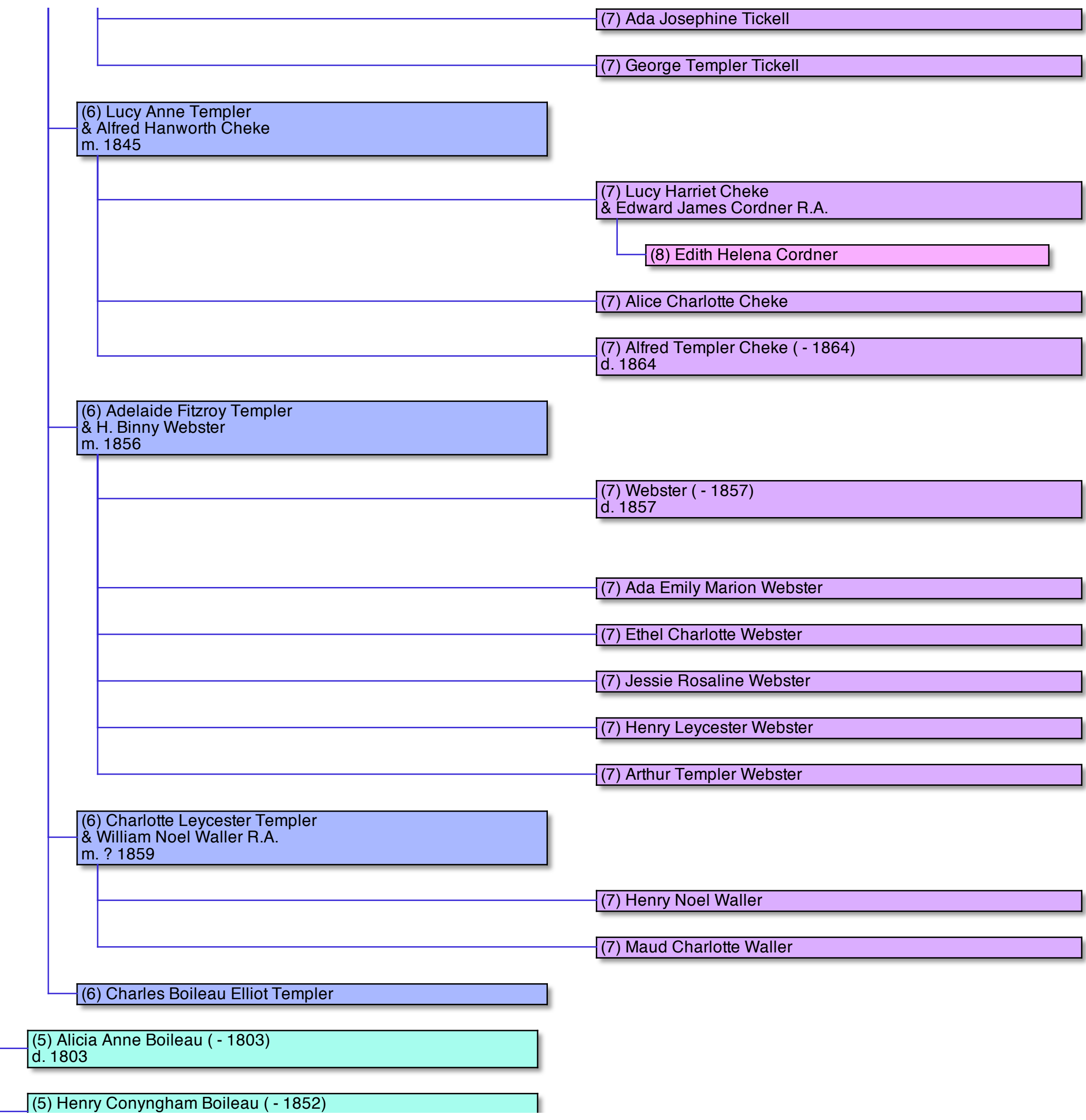

d. 1852

(5) Major General Francis Burton Boileau R.A.  
& Sarah Durie  
m. 1834

(6) Francis William Boileau  
& Lititia Bradford  
m. 1861

(7) Fanny Boileau

(7) Claude Boileau

(7) Percy Boileau

(6) Charles Henry Boileau  
& Susanna Le Bailly  
m. 1863

(7) Helen Louisa Boileau ( - 1866)  
d. 1866

(6) Sarah Boileau  
& M.A. Lang

(7) Grace Lang

(7) Ethel Lang

(7) Arthur Lang

(7) Elliott Lang

(7) Lillian Lang

(7) Ellen Lang

(6) Anne Boileau ( - 1841)  
d. 1841

(6) Grace Boileau

(6) George Claude Robert Boileau ( - 1842)  
d. 1842

(6) Frederick Durie Boileau ( - 1865)  
d. 1865

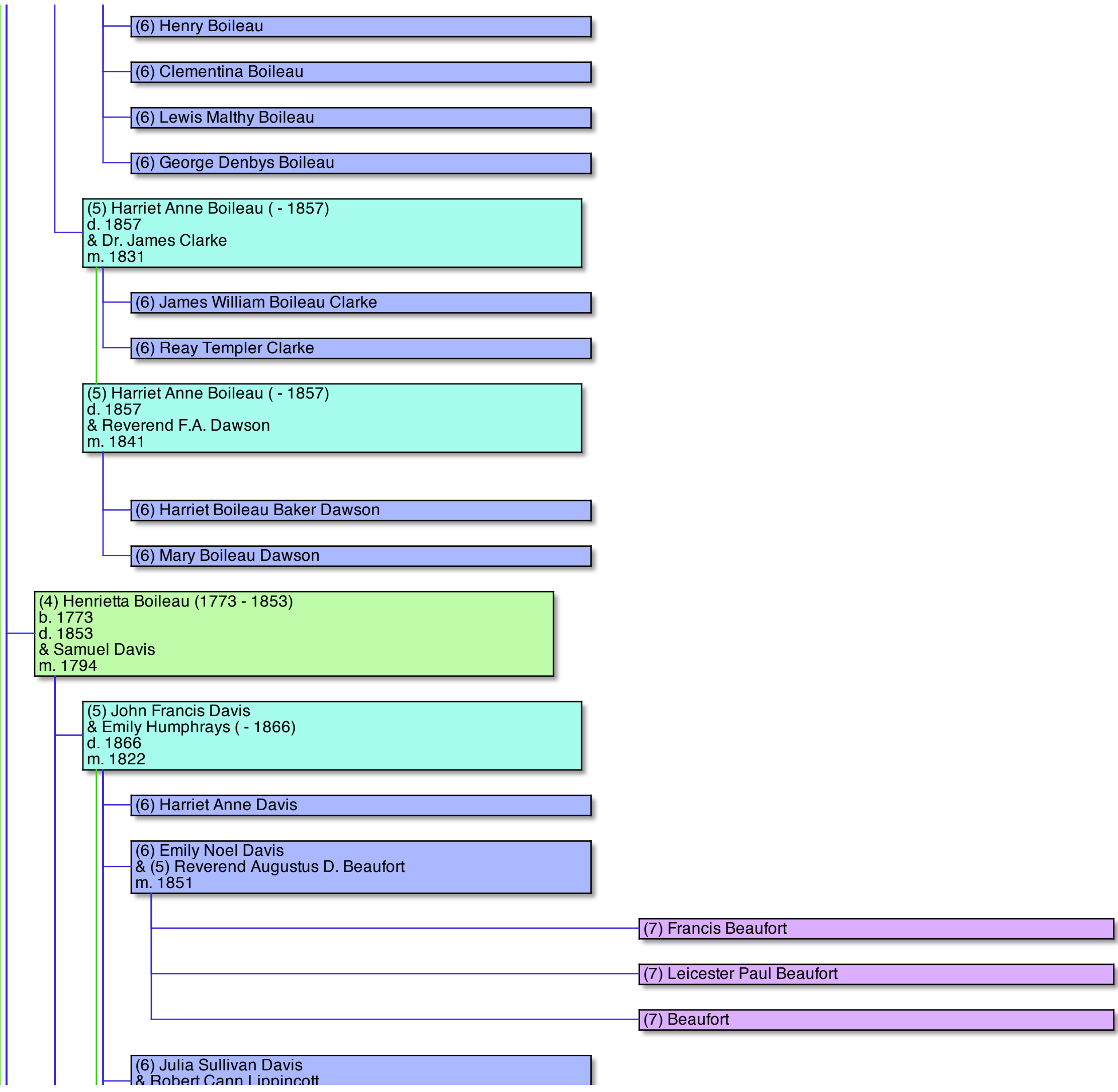

m. 1854

(6) Sullivan Francis Davis ( - 1863)  
d. 1863  
& Agnes M. Middleton

(6) Helen Marion Davis ( - 1859)  
d. 1859

(6) Florence Davis  
& James Burnie Lind

(6) Eliza Davis

(5) John Francis Davis  
& Lucy Ellen Roche  
m. 1867

(5) Harriet Anne Davis ( - 1796)  
d. 1796

(5) Harriet Davis ( - 1866)  
d. 1866  
& Henry Baynes Ward  
m. 1821

(6) Henrietta Mary Ward

(6) George Ward ( - 1857)  
d. 1857  
& Mary E. Roberts

(7) Gertrude Laura Ward

(7) Lillian Mary Ward

(7) George Ward ( - 1864)  
d. 1864

(7) Ward ( - ?186)  
d. ? 186

(7) Ethel Florence Ward

(6) John Robert Ward ( - 1857)  
d. 1857  
& (6) Eliza Catherine Hawkins  
m. 1850

(7) Emily Harriett Ward

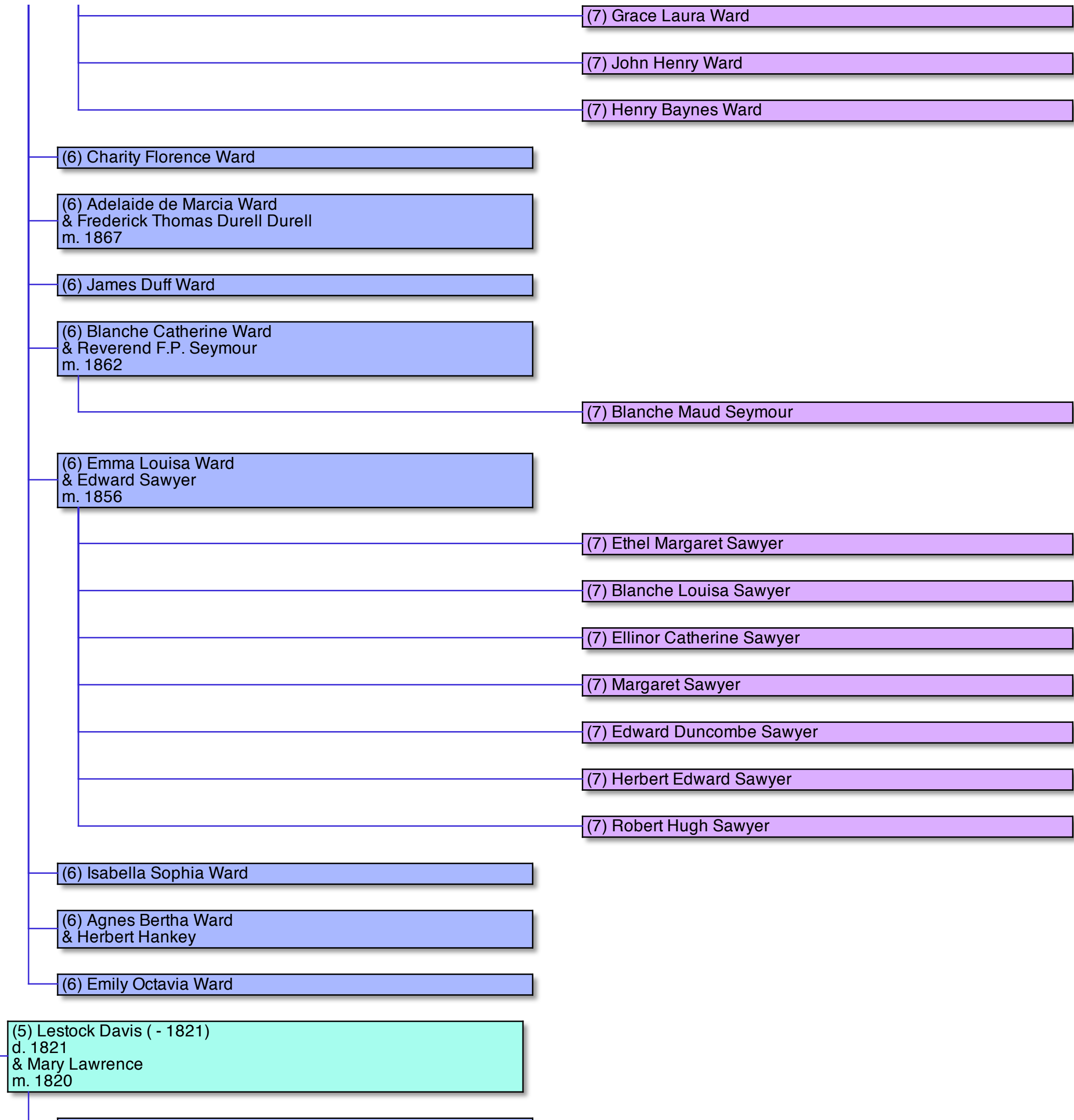

(6) Mary Lestock Davis  
& George Paton  
m. 1843

(7) Agnes Mary Paton

(7) Alice Henrietta Paton

(5) Sullivan Davis (- 1821)  
d. 1821

(5) Anne Marie Davis  
& Henry Dundas Campbell  
m. 3 Jul 1827

(6) Henrietta Georgina Campbell  
& Alexander Shank B.C.S.  
m. 1847

(7) Amey Georgina Shank

(7) Henry Alexander Shank

(7) Julia Alice Shank

(7) Anna Maria Shank

(7) Shank

(7) Shank

(6) Duncan Campbell (- 1830)  
d. 1830

(6) Maria Jane Campbell

(6) Frances Eliza Campbell  
& Oswald Augustus Grimstone  
m. 1836

(7) Grimstone

(7) Brenda Grimstone

(7) Oswald Dundas Grimstone

(7) Sylvester Grimstone

(7) Grimstone



(6) Campbell ( - 1838)  
d. 1838

(5) Maria Davis  
& John Rivett Carnac  
m. 1826

(6) James Carnac ( - 1831)  
d. 1831

(6) Henrietta Carnac

(6) Anna Maria Carnac

(6) Eliza Mary Carnac  
& William H. Tilghman Huskisson  
m. 1858

(6) John Henry Carnac

(6) Edward Stirling Carnac

(6) Arthur Boileau Carnac

(5) Eliza Davis ( - 1860)  
d. 1860  
& Sir Henry Willock Kt.  
m. 3 Jul 1827

(6) Francis Gore Willock ( - 1857)  
d. 1857  
& Matilda McKean  
m. 1856

(7) Francis Henry Willock

(6) Harriet Ellen Willock  
& William Wynyard B.C.S.  
m. 1856

(7) Ellinor Louisa Wynyard

(7) Lilly Sophia Wynyard

(7) Edward Wynyard

(7) William Bingham Wynyard

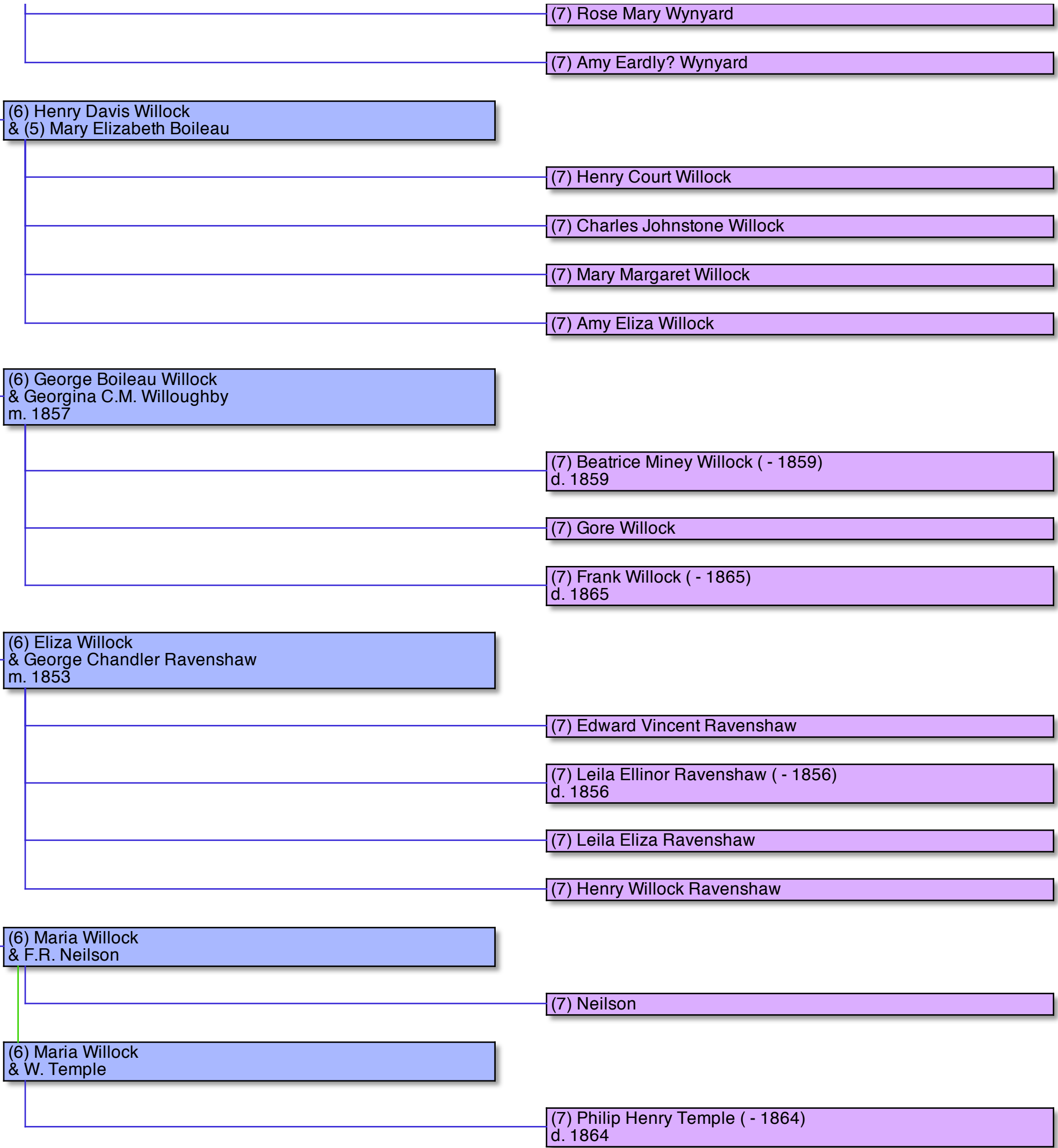

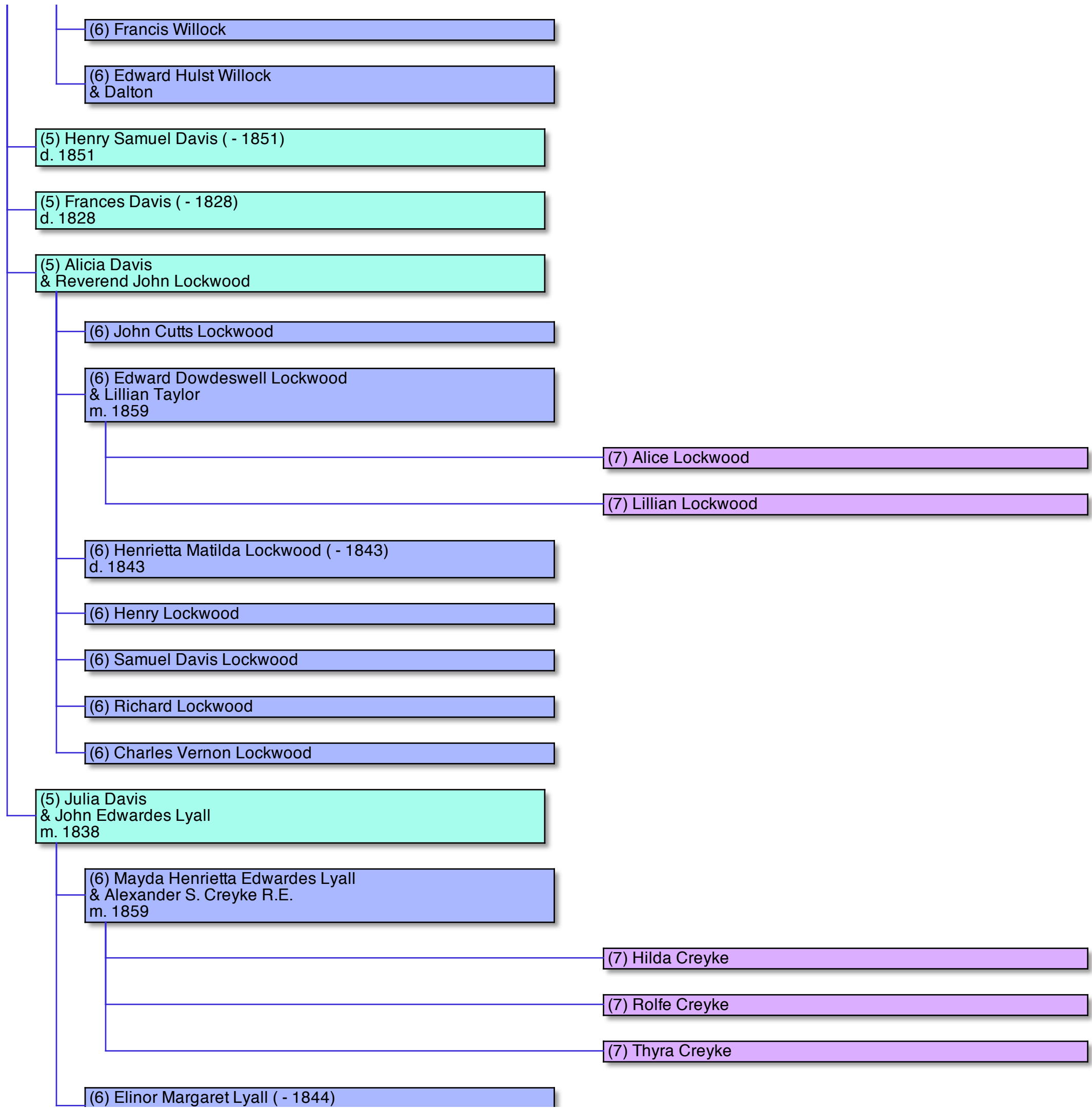

d. 1844

(4) Charles John Boileau (1775 - 1776)  
b. 1775, Dublin  
d. 1776, Dublin

(4) Dorothea Boileau (1776 - 1777)  
b. 1776  
d. 1777

(4) Lucy Boileau (1777 - 1778)  
b. 1777  
d. 1778

(4) Charlotte Boileau (1778 - 1778)  
b. 1778  
d. 1778

(4) Alicia Boileau (1779 - 1851)  
b. 1779  
d. 1851  
& Charles Elliott  
m. 1802

(5) Charles Boileau Elliott  
& Emily Dougan  
m. ? 1831

(6) Alicia Eling Elliott  
& Reverend J. D. Cane  
m. ? 1863

(7) Mary Emily Cane

(6) Charles Pearson Elliott  
& Hannah Frances Lister  
m. ? 1852

(7) Frances Elizabeth Boileau Elliott ( - 1863)  
d. 1863

(7) Charles Lister Boileau Elliott

(7) Alicia Mary Elliott ( - 1866)  
d. 1866

(6) Henry Vernon Wingfield Elliott ( - 1835)  
d. 1835

(6) William Henry Elliott ( - 1844)  
d. 1844

(6) Emily Eugenia Elliott  
& Reverend John Barton  
m. ? 1865

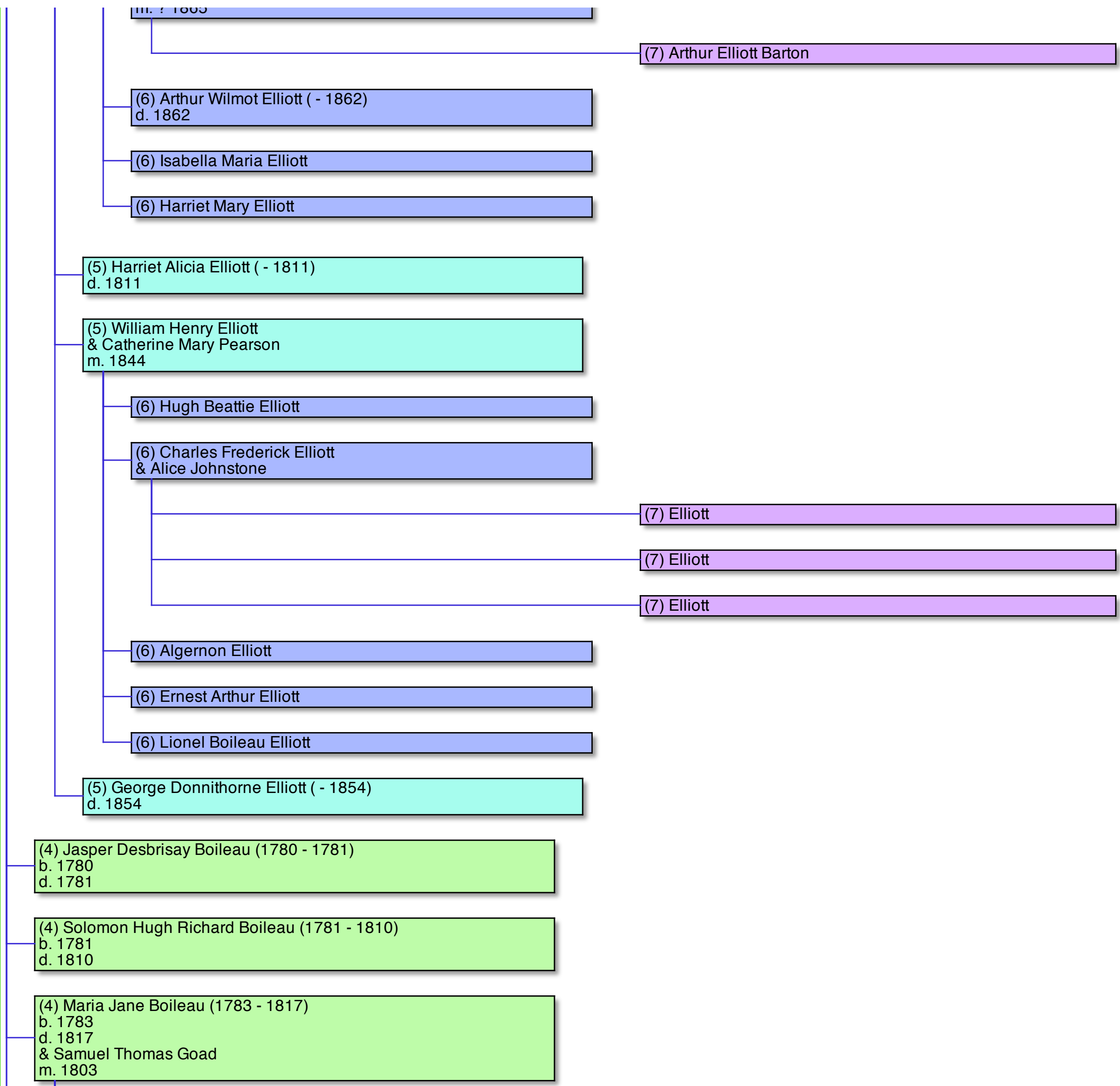

(5) Maria Darling Goad  
& John Ross Sodon  
m. 1830

(6) George Ross Sodon  
& Mary Balchin

(6) Emma Mary Sodon  
& Percy Marsh Sharpe  
m. 1855

(6) John Edward Sodon  
& Helen Bayne

(6) Charles Boileau Sodon ( - 1838)  
d. 1838

(6) Mary Eliza Sodon  
& Francis Richard Hales

(6) Clara Jane Sodon

(6) Octavius Goad Sodon ( - 1848)  
d. 1848

(6) Frederick Brewer Sodon

(6) Henry Cecil Sodon

(5) Samuel Boileau Goad  
& Emma G. Davidson  
m. 1832

(6) Horace Boileau Goad

(6) Clara Sophia Goad  
& John De Heley Mavesyn Chadwick

(7) Hugo Mavesyn Chadwick

(7) Clara Mavesyn Chadwick

(7) Charles Chadwick

(7) Eliza Catherine Chadwick

(7) John De Heley Mavesyn Chadwick

(6) Frederick Theophilus Goad

(6) Ada Maria Goad  
& Edward Webber

(7) Hugh Webber

(7) Evelyn Julia Webber

(6) Julia Catherine Goad

(5) Samuel Boileau Goad  
& Frederika Blood

(6) Samuel Goad

(6) Amy Goad

(5) William Parker Goad ( - 1843)  
d. 1843  
& Jane Kellet  
m. ? 1832

(6) Twins Goad ( - 1833)  
d. 1833

(6) Emily Catherine Goad  
& Charles M. Roche  
m. 1854

(7) Charles St. John Kellet Roche

(5) Henry Goad ( - 1814)  
d. 1814

(5) Charles Elliott Goad  
& Harriet Reilly  
m. ? 1834

(6) Charles Reilly Goad ( - 1857)  
d. 1857

(6) William Trickett Goad

(6) Charlotte Darling Goad ( - 1841)  
d. 1841

(6) George Sodon Goad

(6) Frederick Lampson Goad

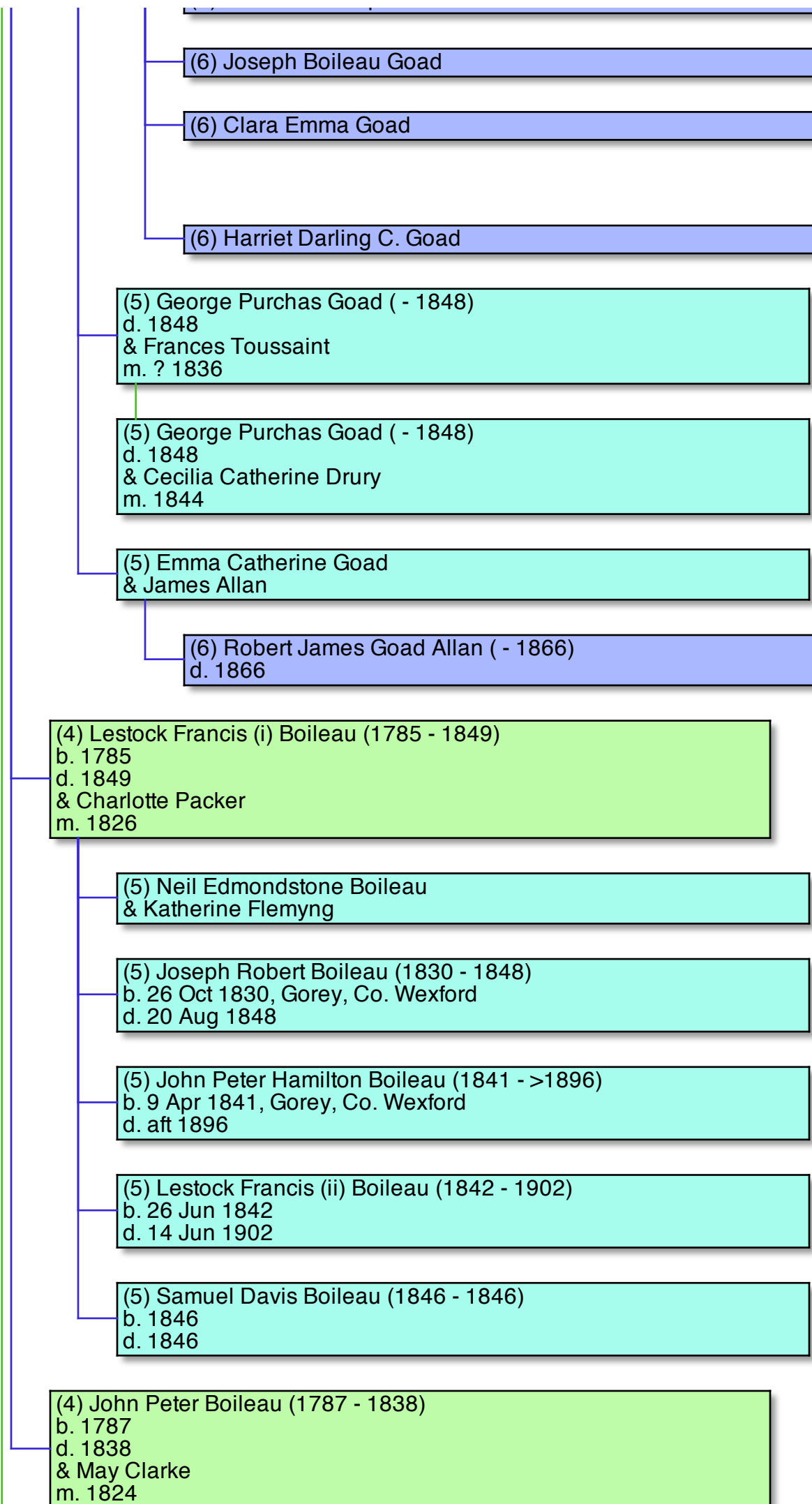



(5) Thomas Theophilus Boileau  
& Jessie Mackintosh  
m. ? 1848

(6) George Theophilus Saunders Boileau

(6) Charles Brandrum Boileau

(6) Amy Somers Boileau  
& David Robertson  
m. 1875

(7) Frank ?? Boileau Robertson

(7) Mabel Constance Elizabeth Robertson

(7) Erica ?? Josephine Robertson

(6) Lestock Holme Drummond Boileau ( - 1858)  
d. 1858

(6) Mabel Jessie Boileau  
& G. Stuart Henderson

(6) Herbert Edward Boileau

(6) Blanche Rosa Boileau

(5) John Peter (vi) Boileau (1827 - 1828)  
b. 31 May 1827  
d. 30 Jun 1828

(5) Charles Elliot Boileau ( - 1857)  
d. 1857

(5) Simeon Richard Boileau ( - 1840)  
d. 1840

(5) Lestock Alexander Boileau ( - 1853)  
d. 1853

(5) Isabelle Annie Boileau  
& Edward Wood  
m. 1858

(6) George Hamilton Wood ( - 1859)  
d. 1859

(6) Madeline Wood

(6) Maud Boileau Wood

(6) Gordon Edward Boileau Wood

(3) Solomon (i) Boileau, 5G Uncle (1745 - 1810)  
b. 31 Jan 1745  
d. 2 Dec 1810  
& Lucy Slater  
m. 1792

(4) Dorothea Boileau (1793 - 1865)  
b. 1793  
d. 1865  
& Ellis Jones  
m. 1820

(5) Maria Dorothea Jones ( - 1853)  
d. 1853  
& Samuel Crane Fox

(6) ?? Jeannette Anne Fox

(6) Alicia Dorothea Fox

(6) Molesworth Boileau Fox

(5) Emma Frances Jones  
& Harry Wooldridge

(6) Harry Ellis Wooldridge

(6) Thomas Wooldridge

(6) George Desbrisay Wooldridge

(6) Charles Simeon Wooldridge

(6) Lestock Boileau Wooldridge

(6) Theophilus Richard Wooldridge

(6) Emma Frances Wooldridge

(6) Arthur Wells Wooldridge

(6) Philip Boileau Wooldridge

(6) Reginald Boileau Wooldridge

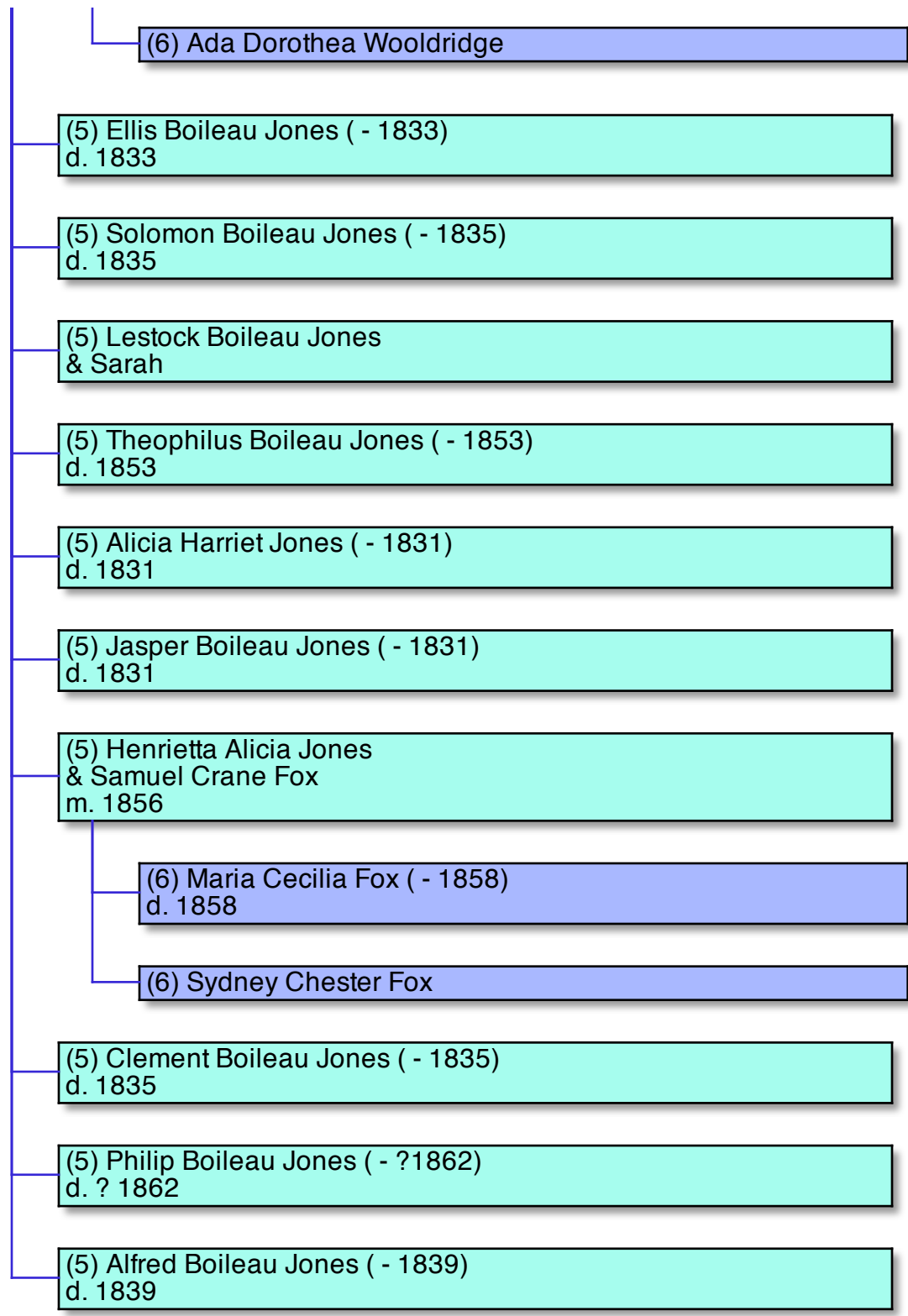

(3) Simeon (ii) Boileau, 5G Uncle (1745 - 1746)  
b. 13 Dec 1745, Eg. Fr. Unies, Dublin  
d. 1746

(3) John Peter (i) Boileau, 5G Uncle (1747 - 1837)  
b. 30 Nov 1747  
d. May 1837  
& Henrietta Pollen  
m. 1790

(4) Henrietta Maria Boileau (1793 - 1837)  
b. 1793  
d. 1837  
& Dr. John Scott  
m. 1828

(5) Henrietta Maria Scott  
& John Johnstone  
m. 1851

(6) Henrietta Maria Jane Johnstone  
& Barrington  
m. 1873

(6) Mary Helen Johnstone

(6) Isabella Scott Johnstone

(6) Andrew Scott Johnstone

(6) Charles Lawrence Johnstone

(4) John Peter (iii) Boileau (1793 - 1793)  
b. 11 Apr 1793, Hertford St, Mayfair, London  
d. 12 Apr 1793

(4) Sir John Peter (iv) Boileau Bart. (1794 - 1869)  
b. 1794  
d. 1869  
& Lady Catherine Sarah Elliott  
m. 1825

(5) Anna Maria Boileau  
& Reverend William Hay Gurney

(5) John Elliot Boileau (- 1861)  
d. 1861

(5) Caroline Mary Boileau (- 1877)  
d. 2 Apr 1877

(5) Francis George Manningham Boileau (1830 - 1900)  
b. 1830, Thursford Hall, Norfolk  
d. 1900  
& Lady Henrietta Nugent  
m. 1869, Hanover Square, London

(5) Edmund William Pollen Boileau (1831 - 1883)  
b. 1831  
d. 1883  
& Bridget Walsh

(5) Agnes Lucy Boileau  
& Honourable William J. Vernon  
m. 1855

(6) Reginald William Vernon

(5) Charles Augustus Penrhyn Boileau ( - 1855)  
d. 1 Aug 1855

(5) Mary Georgina Boileau

(5) Theresa Anne Catherine Boileau ( - 1872)  
d. 1872

(4) George Pollen Boileau-Pollen (1798 - 1847)  
b. 1798  
d. 1847  
& Elizabeth Primrose Hall ( - 1873)  
d. 1873  
m. 1824

(5) John Douglas Boileau-Pollen ( - 1906)  
d. 1906

(5) Georgina Boileau-Pollen

(5) Charles Edward Boileau-Pollen

(5) Elizabeth Boileau-Pollen  
& Andrew Coventry

(4) Charles Lestock Boileau (1800 - 1889)  
b. 1800  
d. 1889  
& Emily Adam (1814 - 1833)  
b. 1814  
d. 1833, Bangalore  
m. 1833

(4) Charles Lestock Boileau (1800 - 1889)  
b. 1800  
d. 1889  
& Margaret Stirling  
m. 1836

(5) Mary Elizabeth Boileau  
& (6) Henry Davis Willock

(6) Henry Court Willock

(6) Charles Johnstone Willock

(6) Mary Margaret Willock

(6) Amy Eliza Willock

(4) Charles Lestock Boileau (1800 - 1889)  
b. 1800

d. 1889  
& Maria Wenham  
m. 1848

(3) Anne Charlotte Boileau, 5G Aunt (1748 - )  
b. 19 Nov 1748, Eg. Fr. Unies, Dublin  
& Peter Friell

(4) Magdalene Friell (1772 - 1845)  
b. 1772  
d. 1845  
& John Lumsden  
m. 1793

(5) Charlotte Lumsden ( - 1837)  
d. 1837  
& William Henry Trant  
m. ? 1812

(6) Magdalene Elinor Trant  
& (5) Neil Benjamin Edmonstone  
m. 1840

(7) Neil Benjamin Edmonstone

(7) William Henry Edmonstone

(6) Henry John Trant

(5) Rachel Lumsden

(5) John Lumsden

(5) William Lumsden

(5) Eliza Henrietta Lumsden  
& (4) John Peter Wilson (1791 - 1832)  
b. 1791  
d. 1832  
m. 1822

(6) John Wilson ( - 1831)  
d. 1831

(6) Mary Frances Wilson ( - 1828)  
d. 1828

(6) Bonne Wilson ( - 1827)  
d. 1827

(6) Alicia Ellen Wilson ( - 1850)  
d. 1850

(6) John Peter Wilson  
& Sarah Blakeway  
m. 1857

(7) Lestock Weatherley Wilson

(7) Sidney Manthorp Wilson

(7) James Seton Wilson

(7) Charles Willan Wilson

(7) Francis Beaufort Wilson

(5) Eliza Henrietta Lumsden  
& Sir William Coote Seton Bart.  
m. 1834

(6) James Lumsden Seton

(6) William Samuel Seton

(6) Eliza Seton

(6) Henry Seton

(6) Magdalene Frances Seton

(6) Matthew Seton

(6) Frances Seton

(6) Charles Seton

(5) Alicia Lumsden ( - 1828)  
d. 1828  
& (5) Edward Simeon Hawkins ( - 1840)  
d. 1840  
m. 1826

(6) Magdalen Sophia Hawkins

(5) Sophia Lumsden ( - 1864)  
d. 1864

(5) Henry Thomas Lumsden ( - 1867)  
d. 1867  
& (5) Susanna Edmonstone  
m. 1832

(5) Lydia Edmonstone Lumsden  
& Reverend Robert Samuel Battiscombe  
m. 1851

(5) Harriet Peach Lumsden  
& George C. Cheape  
m. 1845

(4) Rachel Friell (1773 - )  
b. 1773  
& Abraham Welland  
m. 1793

(4) Charlotte Anne Friell (1775 - 1838)  
b. 1775  
d. 1838  
& Neil Benjamin Edmonstone

(5) William Archibald Edmonstone

(5) Charlotte Anne Edmonstone  
& James Carnegie  
m. 1819

(5) Charlotte Anne Edmonstone  
& Reverend John Hodgson

(5) Henrietta Dashwood Edmonstone

(5) Susanna Edmonstone  
& (5) Henry Thomas Lumsden ( - 1867)  
d. 1867  
m. 1832

(5) Neil Benjamin Edmonstone  
& (6) Magdalene Elinor Trant  
m. 1840

(6) Neil Benjamin Edmonstone

(6) William Henry Edmonstone

(5) Charles Welland Edmonstone  
& Susan Mary D'Oyly Douglas  
m. 1842

(6) Susanna Carnegie Edmonstone  
& Reverend John Venn

(6) Mary Douglas Edmonstone ( - 1865)  
d. 1865



(6) Charlotte Anne Edmonstone

(6) Amy Lumsden Edmonstone ( - 1865)  
d. 1865

(6) Frances D'Oyly Edmonstone

(6) Esther Alicia Edmonstone

(5) Sir George Frederick Edmonstone K.C.B.  
& Anne Farly Turner (1826 - 1859)  
b. 1826  
d. 1859  
m. 1843

(6) George Frederick Edmonstone

(6) Emily Louisa Edmonstone

(6) George Frederick Edmonstone

(6) Charles William Edmonstone

(6) Ellen Craigie Edmonstone

(5) Louisa McLeod Edmonstone  
& Reverend Thomas Clements Browne  
m. 1842

(6) Marmaduke Edmonstone Browne

(6) Maria Louisa Browne

(5) Anne Craigie Edmonstone

(5) James Harane? Edmonstone

(5) Alicia Augusta Edmonstone

(4) Duncan? Philip Friell (1779 - 1804)  
b. 1779  
d. 1804

(4) Elizabeth Friell (1781 - )  
b. 1781  
& Colonel Thomas Hawkins  
m. 1803

(5) Elizabeth Hawkins  
& Henry Barkley Henderson  
m. 1822

(6) Elizabeth Mary Henderson ( - 1824)  
d. 1824

(6) Henry Barkley Henderson  
& Mary Nichols

(6) Eliza Jane Henderson

(6) James Lumsden Henderson ( - 1845)  
d. 1845

(6) Frances Mary Henderson  
& Colonel Keith Young  
m. 1852

(7) Keith Henry St. George Young

(7) Arthur Henderson Young

(7) Henry McLeod Young

(7) Helen Constance Young

(7) Margaret Young

(6) Helen Henrietta Carr Henderson

(6) Henrietta Charlotte McGregor Henderson  
& Henry D. Davies  
m. 1857

(7) Constance Mary Davies

(7) Norman Pescott Davies

(6) Margaret Henderson

(6) John Hawkins Henderson ( - 1845)  
d. 1845

(5) John Abraham F. Hawkins  
& (5) Margaret Edmonstone McLeod

(6) John McLeod Hawkins

(6) Robert McLeod Hawkins  
& Agnes Ch. Augusta Marshall

(7) Louisa Mary McLeod Hawkins

(7) Edward Mary McLeod Hawkins

(7) John Charles McLeod Hawkins

(5) Henrietta Alicia Hawkins  
& Joseph Stephen Aldersey  
m. 1832

(6) Suffield Lumsden Aldersey

(6) Frances Mary Aldersey

(6) Alicia Anne Gower Aldersey

(6) Haydon Suffield Aldersey

(6) Haydon Stephen Aldersey

(5) Charlotte Frances Hawkins ( - 1866)  
d. 1866  
& (5) John Theophilus (iv) Boileau ( - 1842)  
d. 1842  
m. 1841

(6) John Theophilus (vi) Boileau (1842 - )  
b. 5 Feb 1842

(4) Henrietta Caroline Lestock Friell (1782 - 1830)  
b. 1782  
d. 1830  
& Duncan McLeod (1780 - 1865)  
b. 1780  
d. 1865  
m. 1803

(5) Jane Alicia McLeod  
& Dr. James Innes  
m. 1828

(6) James John McLeod Innes  
& Lucy Jane Macpherson  
m. 1855

(7) James Edgeworth Innes

(7) Hugh McLeod Innes

(7) Arthur Donald Innes

(6) Henrietta Georgina Forbes Innes  
& Reverend Alexander Luke  
m. 1865

(6) Margaret Clunes Innes ( - 1861)  
d. 1861

(6) Elinor Caroline Pemberton Innes

(6) Innes ( - 1836)  
d. 1836

(6) Duncan McLeod Cranford Innes ( - 1837)  
d. 1837

(6) Jane Alicia Innes ( - 1842)  
d. 1842

(6) Alicia Jane Innes ( - 1843)  
d. 1843

(5) Duncan Cranford McLeod ( - 1832)  
d. 1832

(5) Donald Friell McLeod (1810 - 1872)  
b. 1810  
d. 1872  
& Frances Montgomery (~1835 - 1855)  
b. abt 1835  
d. 1855  
m. 1854

(5) Henrietta Peach McLeod ( - 1854)  
d. 1854  
& Robert Boileau Pemberton

(6) Henrietta Peach Pemberton  
& Sir George Udny Yule K.C.S.I.  
m. 1862

(7) Ettie Elizabeth Yule ( - 1866)  
d. 1866

(7) Mary Margaret Yule

(7) Alice Yule ( - 1868)  
d. 1868

(6) Robert Charles Boileau Pemberton  
& Alice Barrow  
m. 1852

(7) Alice Evelyn McLeod Pemberton

(7) Catherine Pemberton

(7) Annie Gertrude Pemberton

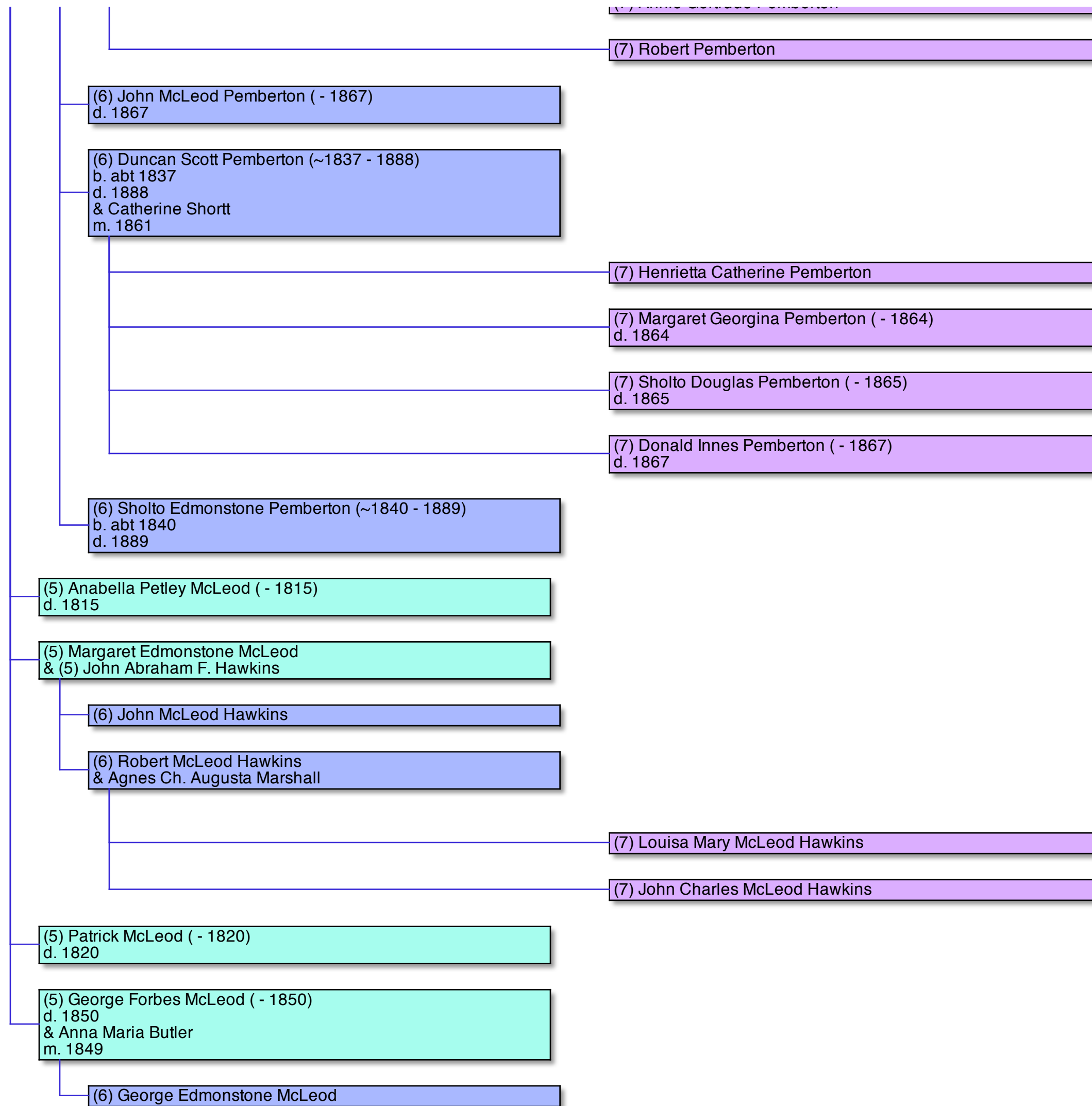

(4) Alicia Friell (1784 - 1821)  
b. 1784  
d. 1821  
& William Percival Potts  
m. 1805

(5) Alicia Eliza Rachel Potts  
& Reverend Robert Samuel Battiscombe

(6) Robert William Percival Battiscombe  
& Eleonora Lambard  
m. 1854

(7) Henry Herbert Battiscombe

(7) George Murray Battiscombe

(7) Percival Francis Battiscombe

(7) Christopher William Battiscombe

(7) Emily Harriet Battiscombe

(7) Eleonora Theresa Battiscombe

(6) Alicia Frances Battiscombe  
& William Percival Salmon  
m. 1855

(7) Alicia Eliza Salmon

(7) Mary Emma Salmon

(7) Edith Frances Salmon

(7) William Henry Salmon

(7) Madeline Cardine Salmon

(7) Charles Edward Salmon

(6) Emma Trant Battiscombe

(6) Henry Lumsden Battiscombe  
& Aurea Lambard

(7) Charles Battiscombe

(7) Henry Battiscombe

(6) Edith Jane Battiscombe  
& Henry Lumsden

(7) Edith Isabella Lumsden

(7) Alice Lumsden

(7) Hugh Robert Lumsden

(7) Walter Lumsden

(4) Alicia Friell (1784 - 1821)  
b. 1784  
d. 1821  
& William Leycester  
m. 1818

(5) George Percival Leycester  
& Caroline Fagan

(6) Caroline Elizabeth Leycester

(6) Alicia Susanna Leycester

(6) George William Leycester

(6) Agnes Mary Leycester

(6) Edward Leycester

(6) Laura Leycester

(6) Robert Fagan Leycester

(5) George Percival Leycester  
& Hannah Danford

(5) Philip Friell Leycester

(5) Ralph William Henry Leycester  
& Emma de Kutzleben(?)  
m. 1839

(5) Charlotte Alicia Leycester  
& George Gordon Macpherson

(6) Charlotte L. Gordon Macpherson ( - 1839)  
d. 1839

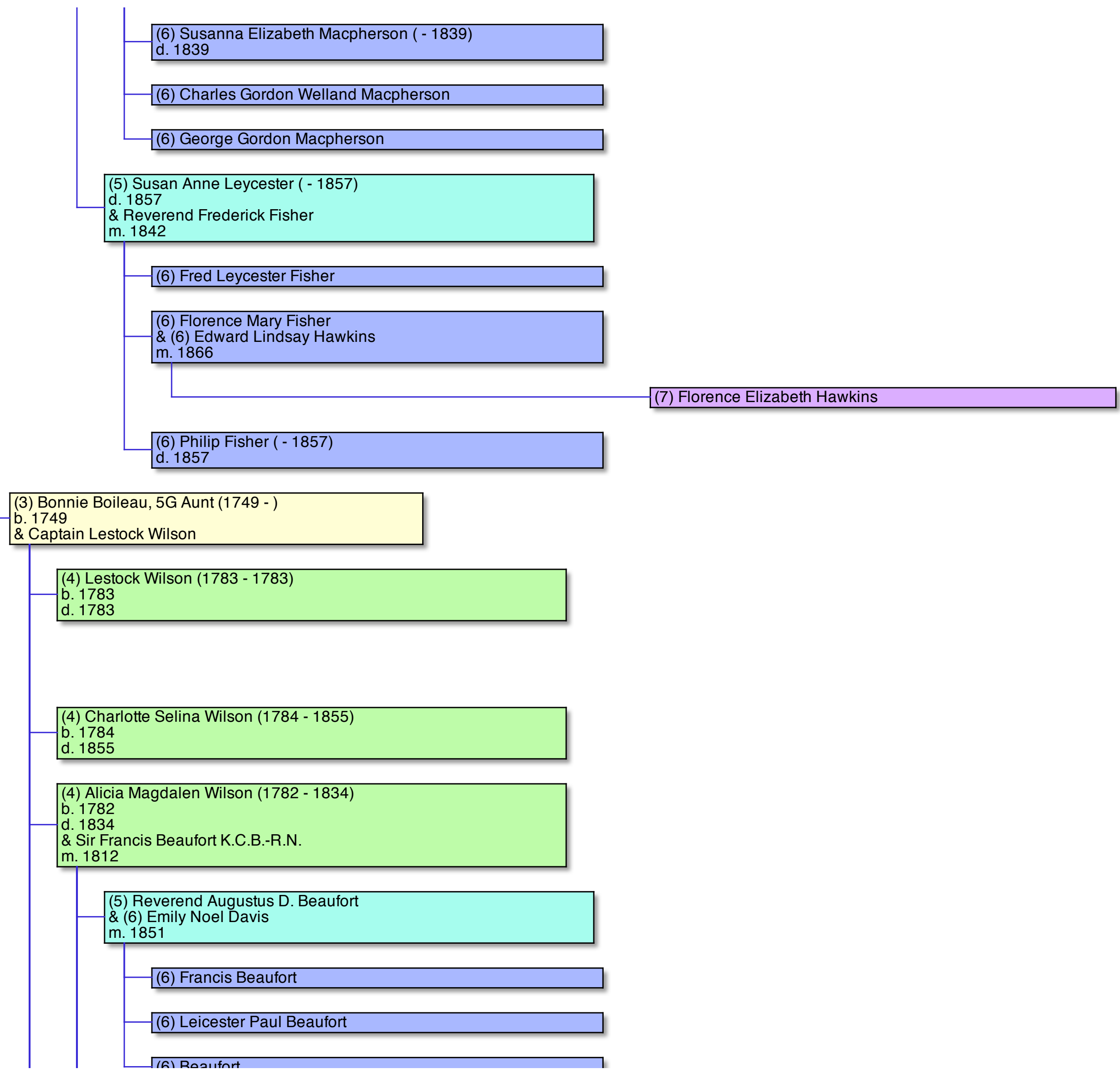



(5) Beaufort

(5) Francis Lestock Beaufort & Mary Chambers

(6) John Francis Chambers Beaufort ( - 1844)  
d. 1844

(6) Alicia Mary Beaufort

(6) Emily Magdeline Beaufort

(6) Augustus Francis Beaufort

(6) Charles Edgeworth Beaufort ( - 1865)  
d. 1865

(6) Agnes de la Cour Beaufort

(6) Cecil Walker Beaufort

(5) Alfred Edgeworth Beaufort

(5) Sophia M. Bonne Beaufort & Sir William Palmer  
m. 1838

(6) Alicia Palmer ( - 1844)  
d. 1844

(6) Emily Alicia Palmer & Reverend Acton Warburton  
m. 1866

(6) Francis Beaufort Palmer

(6) Blanche Mary Sophia Palmer

(5) Rosalind Elizabeth Beaufort

(5) William Morris Beaufort

(5) Emily Anne Beaufort & Viscount Strangford

(4) Eliza Wilson

(4) Lestock Peach Wilson (1788 - )  
b. 1788

& Frances M Edgeworth  
m. 1829

(4) Henry Corneil Wilson

(4) Henrietta Frances Wilson (1789 - 1855)  
b. 1789  
d. 1855  
& John Theophilus Desbrisay (1804 - 1846)  
b. 1804  
d. 1846

(5) George Desbrisay ( - 1840)  
d. 1840

(5) Henry De la Cour Desbrisay  
& Jane Amelia Marett  
m. 1854

(6) Jane Marguerite Desbrisay

(4) John Peter Wilson (1791 - 1832)  
b. 1791  
d. 1832  
& (5) Eliza Henrietta Lumsden  
m. 1822

(5) John Wilson ( - 1831)  
d. 1831

(5) Mary Frances Wilson ( - 1828)  
d. 1828

(5) Bonne Wilson ( - 1827)  
d. 1827

(5) Alicia Ellen Wilson ( - 1850)  
d. 1850

(5) John Peter Wilson  
& Sarah Blakeway  
m. 1857

(6) Lestock Weatherley Wilson

(6) Sidney Manthorp Wilson

(6) James Seton Wilson

(6) Charles Willan Wilson

(6) Francis Beaufort Wilson

(3) Philip Daniel Boileau, 5G Uncle (1751 - ca1771)  
b. 1751  
d. ca 1771

(3) Mary Magdalena Boileau, 5G Aunt (1752 - )  
b. 1752

(3) Henrietta (i) Boileau, 5G Aunt (1753 - )  
b. 1753  
& John Peach

(3) Thomas (i) Boileau, GGGG Grandfather (1754 - 1806)  
b. 14 Dec 1754, Dublin  
d. 11 Jun 1806, Calcutta  
& Leah Jessop, GGGG Grandmother  
m. 24 Mar 1796

(4) Thomas Ebenezer John Boileau, GGG Grandfather (1796 - 1853)  
b. 26 Dec 1796, Calcutta  
d. 8 Feb 1853, Brighton  
& Mary Anne Millar ( - 1831)  
d. 16 Jun 1831  
m. 26 Dec 1817

(5) Thomas Alfred Boileau, Half GGG Uncle (1819 - 1894)  
b. 11 May 1819, South India  
d. 14 Jan 1894

(5) Archibald John Maddy Boileau, Half GGG Uncle (1820 - 1871)  
b. 1820, South India  
d. 1871, Madras  
& (5) Georgina Elizabeth Boileau, 2C4R ( - ca1844)  
d. ca 1844  
m. ca 1844, Dublin

(6) Georgina Fanny Boileau, Half 1C3R ( - 1846)  
d. 1846

(5) Archibald John Maddy Boileau, Half GGG Uncle (1820 - 1871)  
b. 1820, South India  
d. 1871, Madras  
& Lucy Smalley  
m. 1849

(6) Edward Hudson Boileau, Half 1C3R (1850 - 1885)  
b. 1850, South India  
d. 1885, Masulipatam, Madras

(6) Thomas Smalley Boileau, Half 1C3R (1851 - 1933)  
b. 8 Jun 1851, Bellary, India  
d. 25 Dec 1933, London  
& Selina Mary Whicher  
m. 30 Mar 1885, Blackheath

(7) Ethel Selina Hastings Boileau, Half 2C2R

(7) Eileen Lucy Boileau, Half 2C2R

(7) Kathleen Minnie Boileau, Half 2C2R

(7) Digby Whicher Boileau, Half 2C2R (1893 - 1976)  
b. 1893, Blackheath  
d. 1976  
& Winifred Mudie  
m. 1924

(8) Peter Mudie Boileau, Half 3C1R (1926 - )  
b. 2 Jan 1926, York

(7) Edward Bulmer Whicher Boileau, Half 2C2R (1898 - 1918)  
b. 1898, Folkestone, Kent  
d. 3 Oct 1918, Killed in action

(7) Thomas Whicher Boileau, Half 2C2R (1904 - 1990)  
b. 30 Aug 1904, Cranbrook, Kent  
d. 1990

(6) Adeline Lucy Boileau, Half 1C3R

(6) Catherine Harriet Boileau, Half 1C3R

(6) Maria de Chal Boileau, Half 1C3R

(6) Alice Mary Boileau, Half 1C3R

(4) Thomas Ebenezer John Boileau, GGG Grandfather (1796 - 1853)  
b. 26 Dec 1796, Calcutta  
d. 8 Feb 1853, Brighton  
& Ellen Eliza Neale

(4) Thomas Ebenezer John Boileau, GGG Grandfather (1796 - 1853)  
b. 26 Dec 1796, Calcutta  
d. 8 Feb 1853, Brighton  
& Elizabeth Hannah Norgar, GGG Grandmother  
m. 3 Mar 1834, Cuddalore, India

(5) Mary Elizabeth Boileau, GGG Aunt  
& George Elliot Clarke

(5) Ellen Leah Boileau, GG Grandmother (1838 - 1918)  
b. 1838  
d. 10 Aug 1918  
& Reginald John Graham, GG Grandfather (1822 - 1897)  
b. 30 Dec 1822  
d. 22 Jun 1897  
m. 30 Apr 1856

(6) Thomas Henry Boileau Graham, GG Uncle (1857 - 1937)  
b. 29 Jan 1857  
d. 10 Mar 1937

(7) Herbert Henry Cecil Graham, 1C2R (1896 - 1950)  
b. 1896  
d. 1950

(7) Graham, 1C2R

(7) Violet Graham, 1C2R

(7) Eric Charles Graham, 1C2R ( - ?1998)  
d. ? 1998  
& Sylvie

(6) Herbert Reginald Curteis Graham, GG Uncle (1858 - 1880)  
b. 19 Jan 1858  
d. 27 Aug 1880, Malta

(6) Mary Constance Boileau Graham, GG Aunt (1859 - 1859)  
b. 5 Jan 1859  
d. 29 Jul 1859

(6) Caroline Eleanor Graham, GG Aunt (1860 - 1863)  
b. 29 May 1860  
d. 19 Feb 1863

(6) Mary Paulina Caroline Graham, GG Aunt ( - 1931)  
d. 9 Aug 1931  
& Silvanus Key Borton M.A.  
m. 28 Dec 1881

(6) Geraldine Frances Elizabeth Graham, GG Aunt  
& James Cochrane Adam

(7) Violet Estelle Adam, 1C2R (1907 - 1983)  
b. 19 Nov 1907  
d. 4 Feb 1983  
& George Sylvester Grimston (1905 - 1990)  
b. 2 Apr 1905  
d. Sep 1990

(8) Caroline Elizabeth Mary Grimston, 2C1R (1951 - )  
b. 13 Mar 1951  
& Richard Siggins (1953 - )  
b. 31 Jan 1953

(9) Stella Frances Leah Siggins, 3rd Cousin (1986 - )  
b. 24 Jun 1986

(6) Violet Graham, GG Aunt

(6) Violet Graham, GG Aunt

(6) Nona Evelyn Graham, GG Aunt

(6) Georgina Decima Graham, GG Aunt

(6) John Davenport Graham, GG Uncle (1871 - 1931)  
b. 28 Jan 1871  
d. 16 Mar 1931  
& Evelyn Mary Paton (1877 - 1927)  
b. 25 Nov 1877  
d. 11 Nov 1927  
m. 4 Jun 1918

(6) Estelle Alice Graham, GG Aunt (1872 - 1897)  
b. 28 Nov 1872  
d. 25 Nov 1897

(6) Olivia Graham, GG Aunt

(6) Ellen Octavia Graham, G Grandmother (ca1864 - ca1953)  
b. ca 1864  
d. ca 1953  
& James Shiner Bond, G Grandfather (1858 - 1922)  
b. 12 Dec 1858, Beaminster, Dorsetshire, England  
d. 1922, Waikumete Cemetery  
m. 25 (29?) Mar 1905

(7) Catherine Charity Graham Bond, Grandmother (1909 - 1999)  
b. 1909, Hamilton?  
d. 6 Jul 1999, Auckland  
& Alfred Harold Sneyd, Grandfather (1905 - 1906)  
b. 14 Nov 1905, Mangere, Auckland  
d. 22 Jul 1906, Ascot House, Devonport, Auckland  
m. 1934, St Aidan's, Remuera

(8) John Graham Trevellyan Sneyd, Father (1935 - )  
b. 18 Feb 1935, Auckland  
& Rosalie Helen McPherson, Mother (1935 - )  
b. 14 Dec 1935, Blenheim  
m. 14 Dec 1959, Dunedin

(9) Mary Jane Sneyd, Sister (1960 - )  
b. 11 Sep 1960  
& Craig Marshall  
m. 1982

(10) Anna Marshall, Niece

(10) William Marshall, Nephew

(9) Alfred James Robert Sneyd, Source (1962 - )  
b. 14 Nov 1962, Dunedin, New Zealand  
& Monique Isabelle Bahizi (1964 - )  
b. 24 Sep 1964, Lagos, Nigeria  
m. 1987, Brooklyn, New York, US

(10) Sarah Helen Bahizi Sneyd, Daughter (1991 - )  
b. 3 May 1991, Los Angeles, USA

(10) Paul Kirema Bahizi Sneyd, Son (1994 - )  
b. 14 Apr 1994, Los Angeles, USA

(10) Katherine Malaika Sneyd, Daughter (1996 - )  
b. 22 Aug 1996, Christchurch, New Zealand

(9) Catherine Adair Sneyd, Sister (1965 - )  
b. 27 Oct 1965  
& Bernard Coombs

(10) Alice, Niece

(10) Elizabeth, Niece

(10) Douglas, Nephew

(10) Sam, Nephew

(9) Elizabeth Sarah Neal Sneyd, Sister (1968 - )  
b. 4 Aug 1968, Dunedin, New Zealand  
& Craig Michael Utting (1965 - )  
b. 1965, Wellington, NZ  
m. 2001

(10) Alexander James Sneyd, Nephew (1997 - )  
b. 1997, Madison WI, USA

(10) Benjamin John Utting-Sneyd, Nephew (2001 - )  
b. 2001, Wellington, NZ

(10) Catherine Rose Sneyd-Utting, Niece (2002 - )  
b. 2002, Wellington, NZ

(10) Daniel Graham Sneyd-Utting, Nephew (2004 - )  
b. 24 Feb 2004, Wellington, NZ

(9) John Graham Sneyd, Brother (1972 - )  
b. 9 Oct 1972  
& Ravi De Silva

(10) Roshi Sneyd, Nephew

(8) Harold James Sneyd, Uncle (1936 - )

(8) Harold James Sneyd, Uncle (1936 - )  
b. 1 Jun 1936, Auckland  
& Heather

(9) David James Sneyd, 1st Cousin (1964 - )  
b. 14 Sep 1964

(9) Kristin Mary Sneyd, 1st Cousin (1966 - )  
b. 8 Jan 1966

(9) Donna Louise Sneyd, 1st Cousin (1968 - )  
b. 10 Feb 1968

(9) Janine Heather Sneyd, 1st Cousin (1970 - )  
b. 15 Dec 1970

(8) Alfred David Sneyd, Uncle  
& Fiona

(9) Oliver Sneyd, 1st Cousin

(9) Rose Sneyd, 1st Cousin

(7) Ellen Sarah Hamilton (Nellie) Bond, G Aunt (1908 - 1980)  
b. 15 Jan 1908  
d. 24 Mar 1980  
& Clive Tidmarsh ( - 1986)  
d. 22 Oct 1986

(8) Brian Graham Tidmarsh, 1C1R (1934 - )  
b. 7 Oct 1934  
& Helen Meril Shanly  
m. 30 Aug 1958

(9) Angela Helen Tidmarsh, 2nd Cousin (1961 - )  
b. 6 Jan 1961  
& Peter Smyth

(10) Miles Maxwell Tidmarsh-Smyth (1994 - )  
b. 30 Sep 1994, Canberra, Australia

(10) Griffen Galen Tidmarsh-Smyth (1997 - )  
b. 11 Apr 1997, Canberra, Australia

(9) Stephanie Anne Tidmarsh, 2nd Cousin (1963 - )  
b. 18 Jul 1963  
& Simon McKenzie

(10) Timothy Justin Fielden McKenzie (1989 - )  
b. 4 Jan 1989, Dunedin, NZ

(10) James Elliot Webster McKenzie (1993 - )  
b. 4 Apr 1993, Dunedin, NZ

(9) Mrs Ellen Tidmarsh, 1C1R (1941 - )



(8) Mary Ellen Humarsh, OTR (1941 - )  
b. 13 Mar 1941  
& Robert Wilson

(9) Andrew Wilson, 2nd Cousin

(9) Julie Wilson, 2nd Cousin

(9) Michael Wilson, 2nd Cousin

(5) Despreaux John Boileau, GGG Uncle (1842 - 1864)  
b. 1842  
d. 1864

(5) Sarah Anne Boileau, GGG Aunt

(5) Hannah Amelia Boileau, GGG Aunt

(5) Alice Upton Boileau, GGG Aunt

(4) Elizabeth Magdalena Boileau, GGGG Aunt (1798 - )  
b. 1798  
& John Samuel Bosanquet  
m. 1818

(5) Charlotte Elizabeth Leycester Bosanquet ( - 1820)  
d. 1820

(5) Harriet Alicia Bosanquet

(4) Simeon John Boileau, GGGG Uncle (1799 - 1863)  
b. 23 Nov 1799, Calcutta  
d. 15 Jun 1863, Egton  
& Charlotte Tolming  
m. 1835

(5) Rebecca Boileau

(5) Leah Boileau

(5) Charlotte Magdalene de Castelnau Boileau

(5) Sarah A.M. Alicia Boileau

(4) John Peter (v) Boileau, GGGG Uncle (1803 - 1816)  
b. 26 Jan 1803, Calcutta  
d. 8 Feb 1816, Bury St. Edmonds

(4) John Theophilus (iii) Boileau, GGGG Uncle (1805 - 1886)  
b. 26 May 1805, Calcutta  
d. 7 Nov 1886, Notting Hill  
& Anne Hanson  
m. 1820

(5) Anne Leah Boileau  
& Edward Harrison  
m. 1849

(6) Edward Thomas(?) Boileau Harrison

(6) Maria A. B. B. Harrison

(6) Henry A. William B. Harrison ( - 1858)  
d. 1858

(6) Constance M.B. Harrison

(6) Gertrude A.J.B. Harrison ( - 1864)  
d. 1864

(6) Arthur Gordon Harrison

(6) Margaret McLeod Harrison  
& William Inskip Digby Shuttleworth Read

(7) William Dunstan Boileau Read (1897 - )  
b. 1897  
& Mary Helene Baxendale

(8) Francis Digby Boileau Read (1934 - 1965)  
b. 1934  
d. 1965  
& Dorothy Helen Virginia Ellul Sullivan

(9) Dorothea Mary Read

(9) Fiona Bridget Read

(9) Christopher Dunstan Boileau Read (1963 - )  
b. 1963  
& Karen Amanda Smallcorn

(10) James Nicholas Boileau Read

(10) Emma Lucy Read

(7) Hugh Stanley Hely(?) Read (1898 - )  
b. 1898  
& Elizabeth Howard

(5) Boileau ( - 1831)  
d. 1831

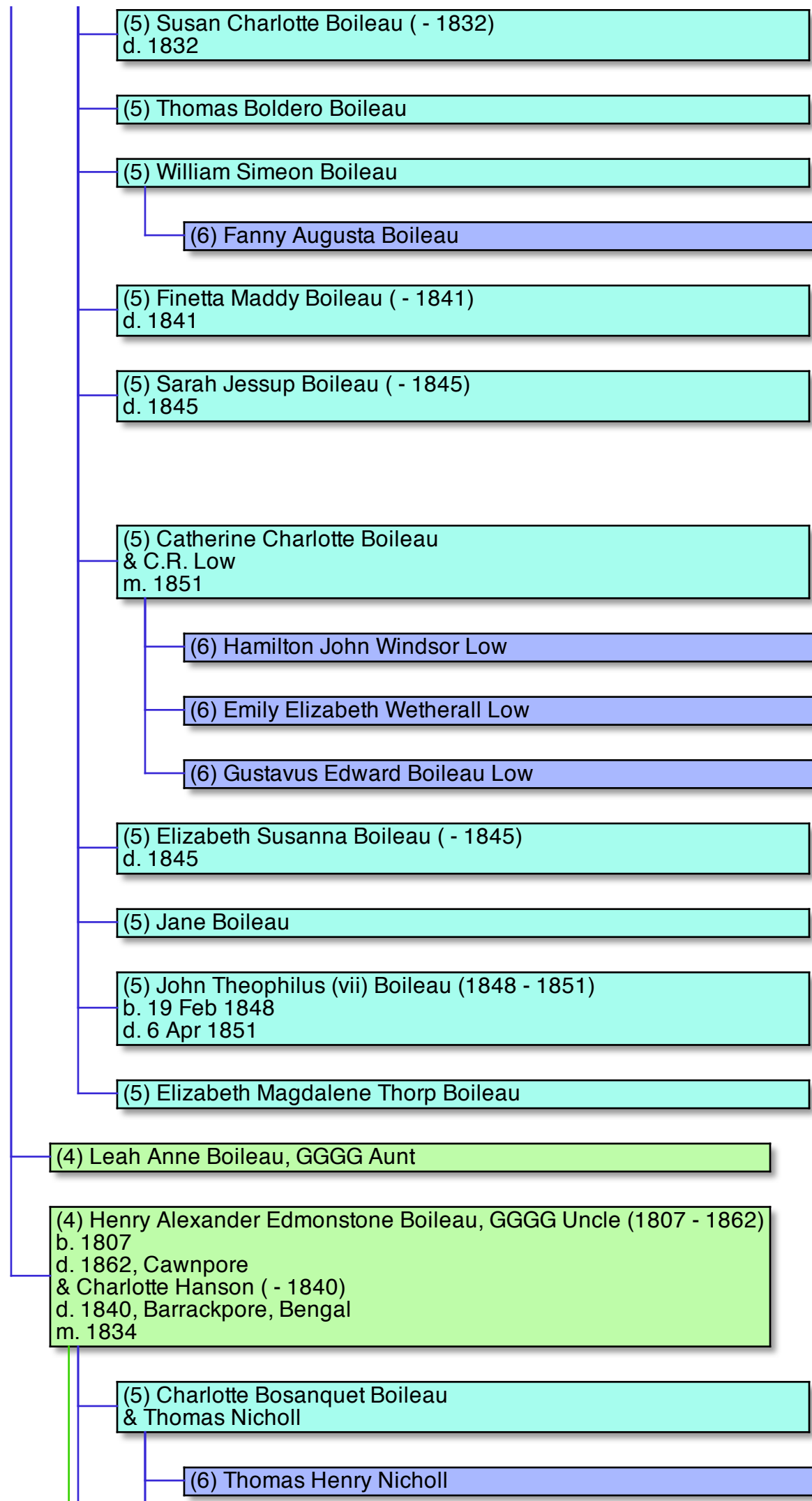

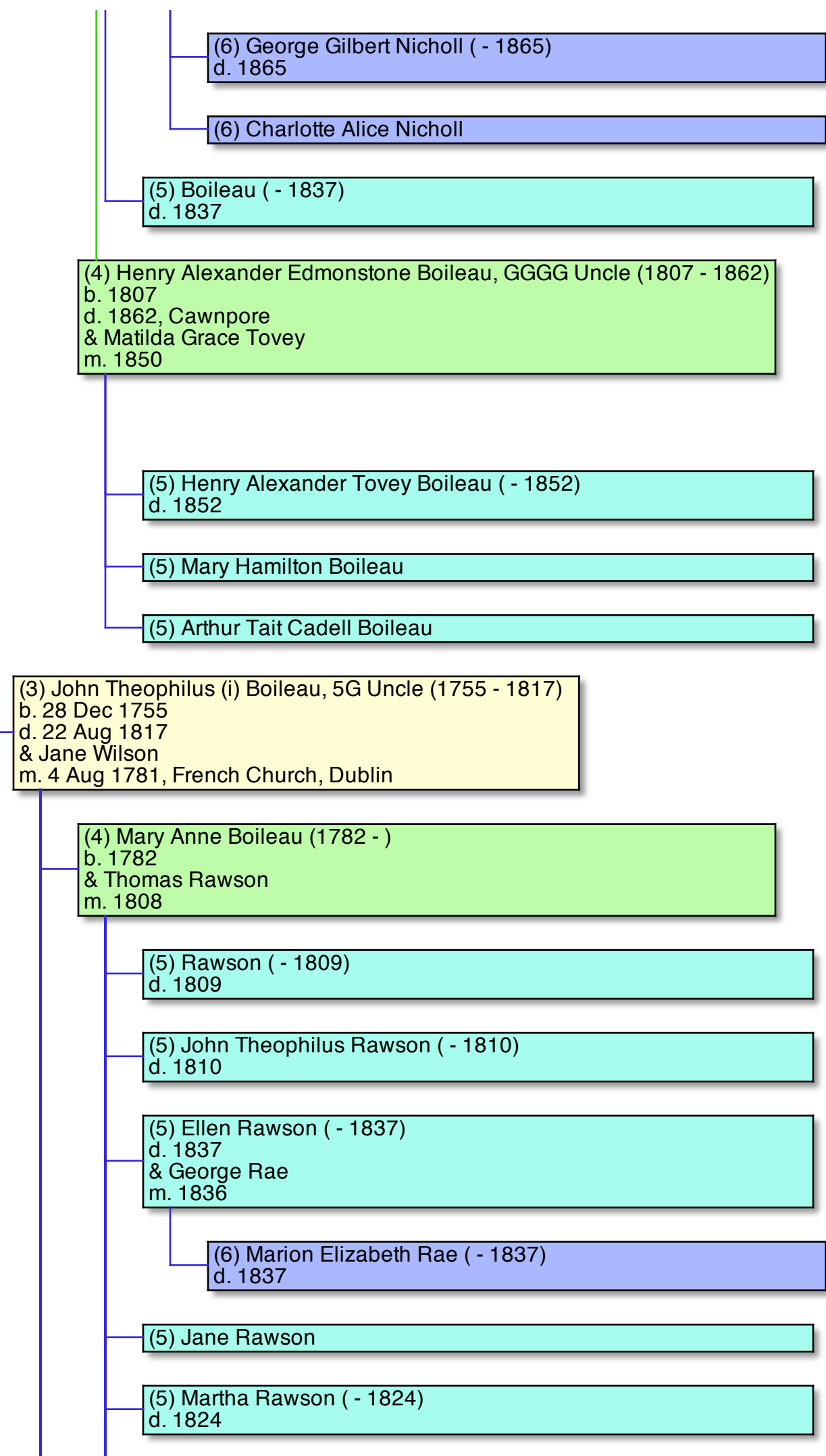

(5) Maria Rawson  
& William D. Duke  
m. 1846

(6) Valentine Duke

(6) Alexander Duke

(6) William Duke

(6) Charles Henry Duke

(6) Arthur Stanley Duke

(5) Marianne Rawson

(5) John Peter Rawson ( - 1817)  
d. 1817

(5) Magdalene Rawson

(5) Thomas Rawson ( - 1822)  
d. 1822

(5) Henrietta Rawson ( - 1821)  
d. 1821

(5) Simeon Rawson  
& Maria Minchin

(6) Thomas Simeon Rawson

(6) Charlotte Jane Rawson

(6) Louis William Rawson

(5) Solomon Rawson

(5) Elizabeth Rawson

(4) Simeon Boileau, 1C5R (1783 - 1848)  
b. 1783  
d. 1848  
& Anne King  
m. 1816

(4) Jane Boileau (1789 - )  
b. 1789  
& Stephen Gaisford  
m. 1814

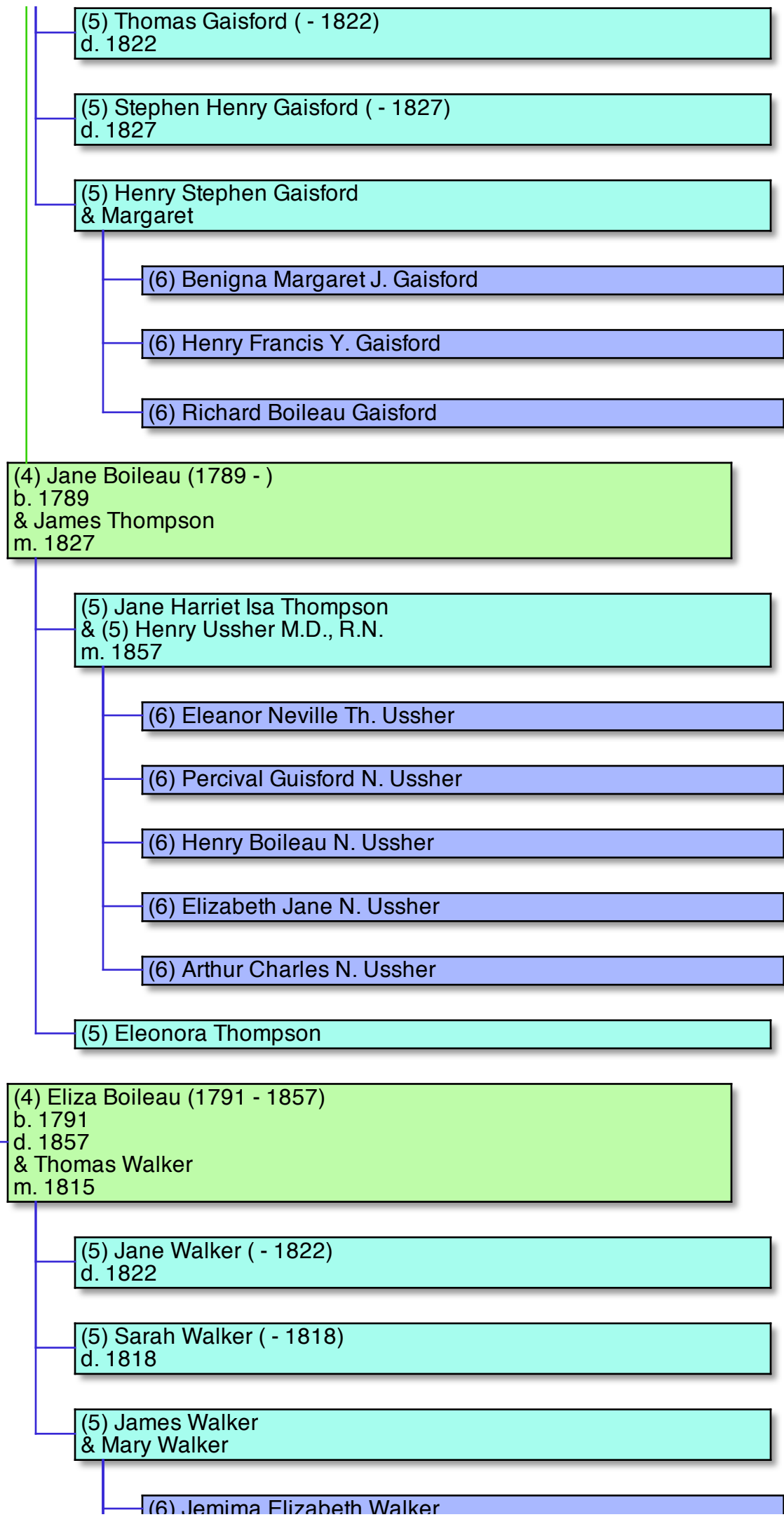

- (6) Robert King Walker
- (6) Marie Louise Walker
- (6) Jane Florence Walker
- (6) Clemence Josephine Walker
- (6) Thomas Elliott Walker

(4) George Wilson (i) Boileau, 1C5R (1793 - 1876)  
 b. 1793, Dublin  
 d. 1876  
 & Anna Rebecca Phipps ( - 1866)  
 d. 1866  
 m. 1819

(5) Georgina Elizabeth Boileau, 2C4R ( - ca1844)  
 d. ca 1844  
 & (5) Archibald John Maddy Boileau, Half GGG Uncle (1820 - 1871)  
 b. 1820, South India  
 d. 1871, Madras  
 m. ca 1844, Dublin

(6) Georgina Fanny Boileau, Half 1C3R ( - 1846)  
 d. 1846

(5) Jane Boileau  
 & Thomas Beckwith Speedy  
 m. 1848

(6) Arthur George Speedy

(6) Thomas Borodale Speedy

(6) Georgina Elizabeth Speedy

(6) Robert Speedy

(5) George Wilson (ii) Boileau  
 & Fanny Elizabeth Knyvett  
 m. 1850

(6) Anna Boileau

(6) Brandrum Theophilus Boileau

(6) George William Knyvett Boileau

(6) Henry Willock Boileau

(6) Colin Campbell Boileau

(6) Blanche Estienne Boileau

(6) Madelaine Harriette Boileau

(6) Mary Theresa Boileau

(6) Knyvett Boileau

(6) Lucy Frances Boileau

(6) Muriel Knyvett Boileau

(6) Edmund Knyvett Boileau

(5) Harriet Boileau  
& Andrew Fraser Baird

(6) George Boileau Baird

(6) Andrew Baird

(6) Caroline Georgina Baird

(6) Anna Emma Frances Baird

(5) Isaac Barry Phipps Spencer Boileau  
& Anne Norton  
m. 1846

(6) Anna Wilson Boileau

(5) John George Boileau  
& Ada Chambers

(5) Simeon Boileau

(5) William Phipps Boileau  
& Louisa Mary Palmer Howell  
m. 1845

(6) William Phipps Boileau

(6) George Boileau



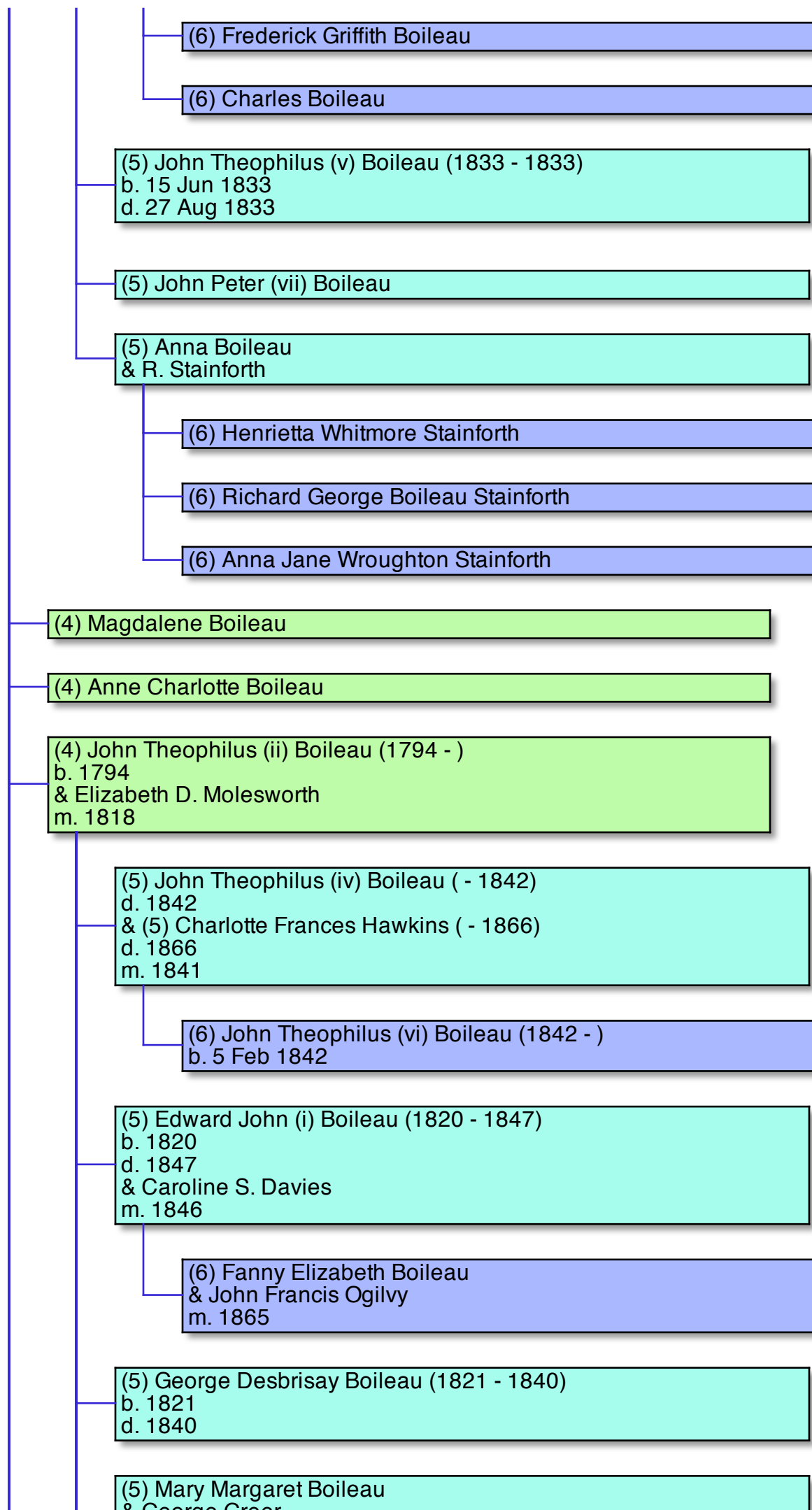

& George Greer  
m. 1865

(5) John George (i) Boileau  
& Ruthana Hunter  
m. 1853

(6) Edward John (ii) Boileau (1854 - )  
b. 1854  
& Sarah Dora Haines  
m. 1876

(7) Edith Sarah Boileau

(7) Kathleen Boileau

(7) Sydney Hunter Boileau

(7) Ethel Boileau

(6) Caroline Frances Boileau

(6) Mary Boileau ( - 1857)  
d. 1857

(6) Thomasina Boileau ( - 1857)  
d. 1857

(6) Jessie Elizabeth Boileau

(6) John Hunter Brandrum Boileau

(5) Anne Jane Boileau

(5) Nassau Molesworth Boileau ( - 1834)  
d. 1834

(5) Jasper Desbrisay Boileau ( - 1834)  
d. 1834

(5) Brandrum Sam Boileau ( - 1834)  
d. 1834

(5) Jane Maria Boileau

(5) Richard Lestock Boileau ( - 1840)  
d. 1840

(5) Henrietta Boileau ( - 1842)  
d. 1842

(4) John Peter (ii) Boileau (1790 - 1818)  
b. 1790  
d. 1 Dec 1818

(4) Harriet Boileau (1795 - 1795)  
b. 1795  
d. 1795

(4) Henrietta Boileau (1798 - )  
b. 1798  
& Richard Beverley Ussher  
m. 1822

(5) John Theophilus Ussher  
& Annabella Ross

(6) Beverley William Reid Ussher

(6) John Kenneth Ussher

(6) Alfred Lestock Ussher

(6) Hamilton O'Brien Ussher

(6) Allen Vesey Ussher

(5) Beverley Ussher  
& Charlotte Emilia Smyth

(6) Mary Eveline Ussher

(6) George Neville Ussher

(6) Charlotte Elizabeth Ussher

(6) Emily Ussher

(6) Georgina Ussher

(5) Henrietta Jane Ussher ( - 1825)  
d. 1825

(5) Henrietta Fanny Jane Ussher ( - 1827)  
d. 1827

(5) Charles Ussher ( - 1830)  
d. 1830

(5) Henrietta Ussher ( - 1831)

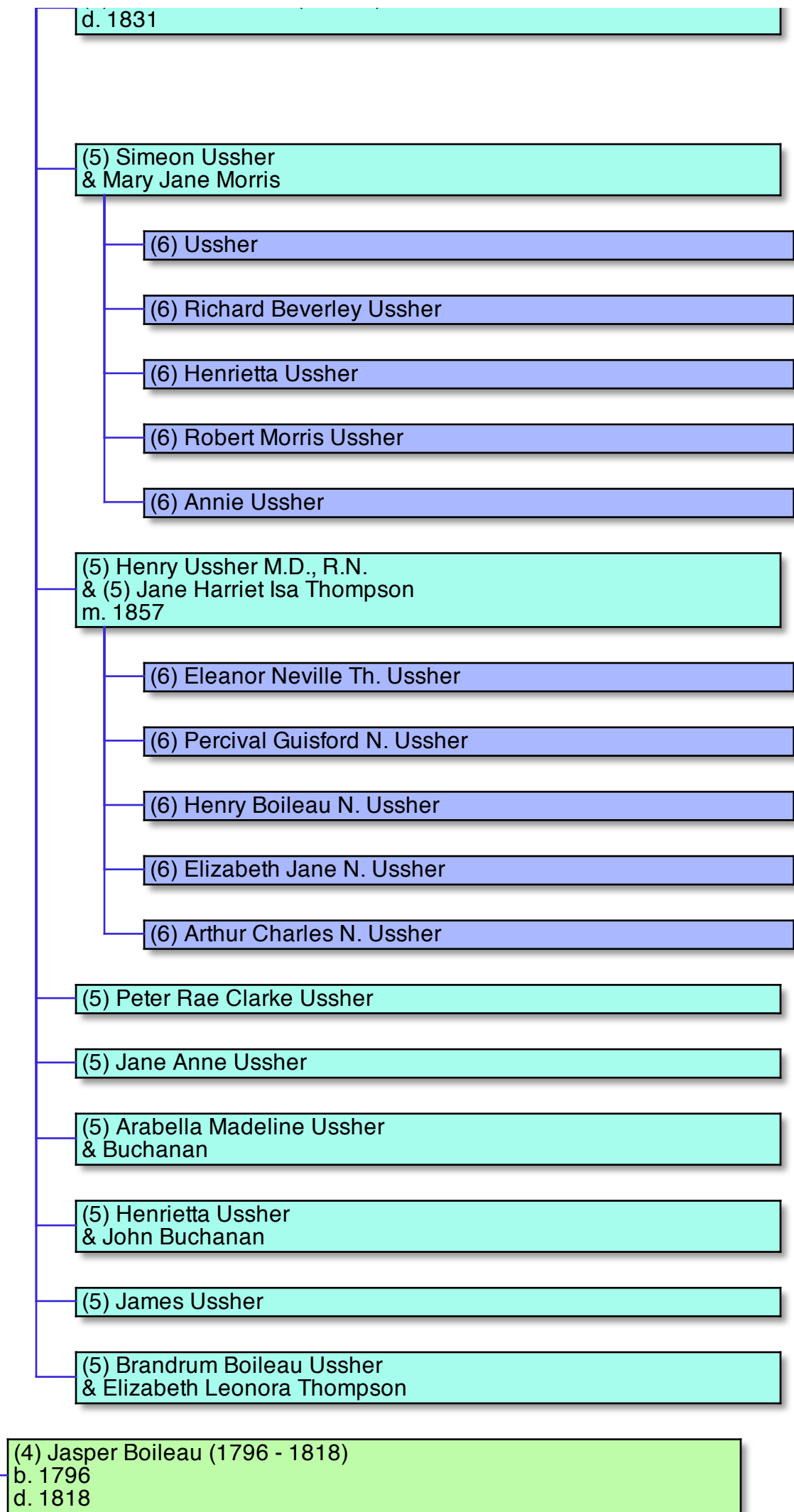

(4) Solomon (ii) Boileau (1800 - 1825)  
b. 15 Mar 1800, Dublin  
d. 14 Dec 1825, Cawnpore

(4) Samuel Brandrum Boileau (1801 - 1860)  
b. 1801  
d. 23 Dec 1860  
& Fanny Bigham ( - 1843)  
d. 1843  
m. 1823

(5) Jane Boileau  
& (5) Lestock Robert Reid M.C.S.

(6) George Boileau Reid

(6) Julia Fanny Eliza Reid

(6) Jane Florence Harriet Reid

(6) Edward Jervis Reid

(6) Ellis Ramsay Reid

(6) William Crawford Reid

(6) Frank Lumsden Reid

(6) Claude Gordon Reid

(6) Arthur Morse Reid

(6) Ada Ruth Erskine Reid

(6) Percy Firth Reid

(6) Ethel Emma Louisa Reid

(6) Mary Rachel Reid

(5) Frances Maria Boileau  
& Reginald F. Remington  
m. 1844

(6) David Samuel Remington

(6) Reginald Frederick Remington

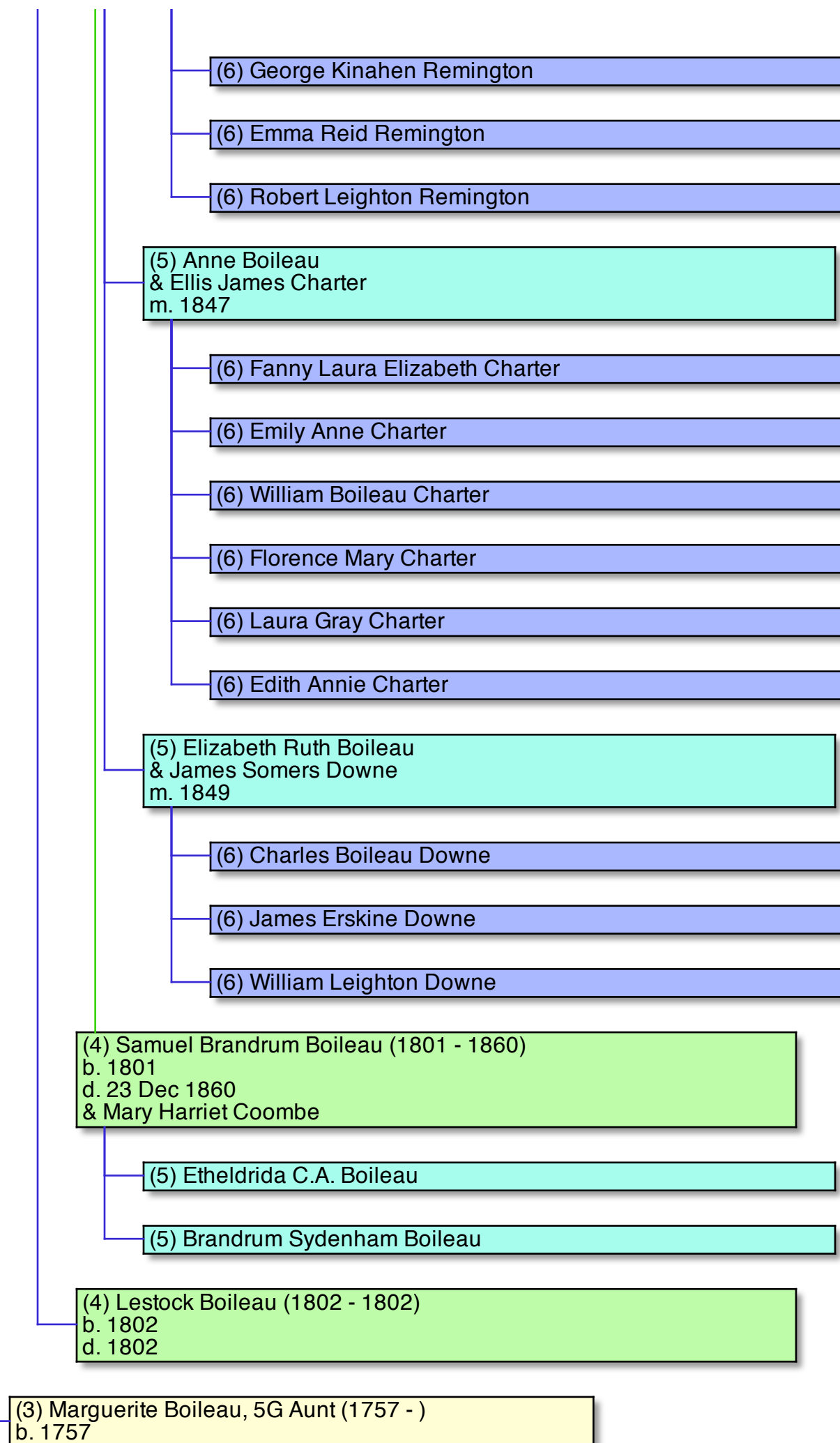

(3) Sarah Boileau, 5G Aunt (1758 - )  
b. 1758

(3) Gaspard Francis Boileau, 5G Uncle (1759 - 1759)  
b. 1759  
d. 1759

(3) Elizabeth Boileau, 5G Aunt (1760 - 1826)  
b. 1760  
d. 1826  
& Michael Carter

(4) Magdalene Carter

(4) Charlotte Grace Carter  
& James Michell  
m. 1810

(5) Mansergh Michell ( - 1811)  
d. 1811

(5) Henry James Michell  
& Foster

(6) Harriette Michell

(5) Daniel Philip Michell  
& Aurora Frederica Cassatt

(6) Henry James Michell

(6) Monckton Washington Michell

(6) Daniel Philip Michell

(6) George Victor Albert Michell

(6) Oscar Eugene Michell

(5) Elizabeth Michell  
& Jeremiah Odell

(5) Samuel Carter Michell ( - 1856)  
d. 1856  
& Mary Michell

(6) Malvern Grace Michell

(6) Cordelia Anne Michell

(5) James Michell

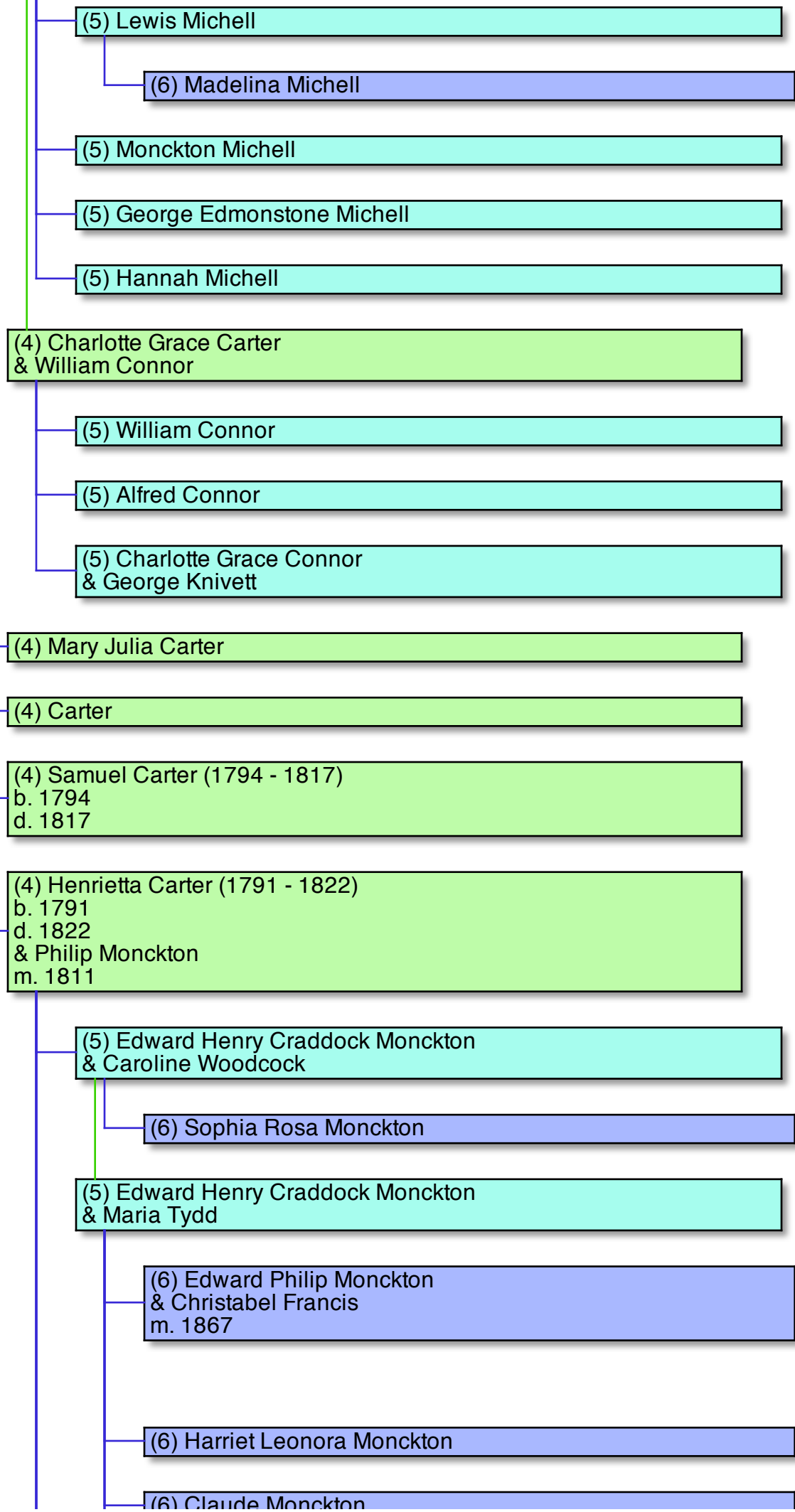



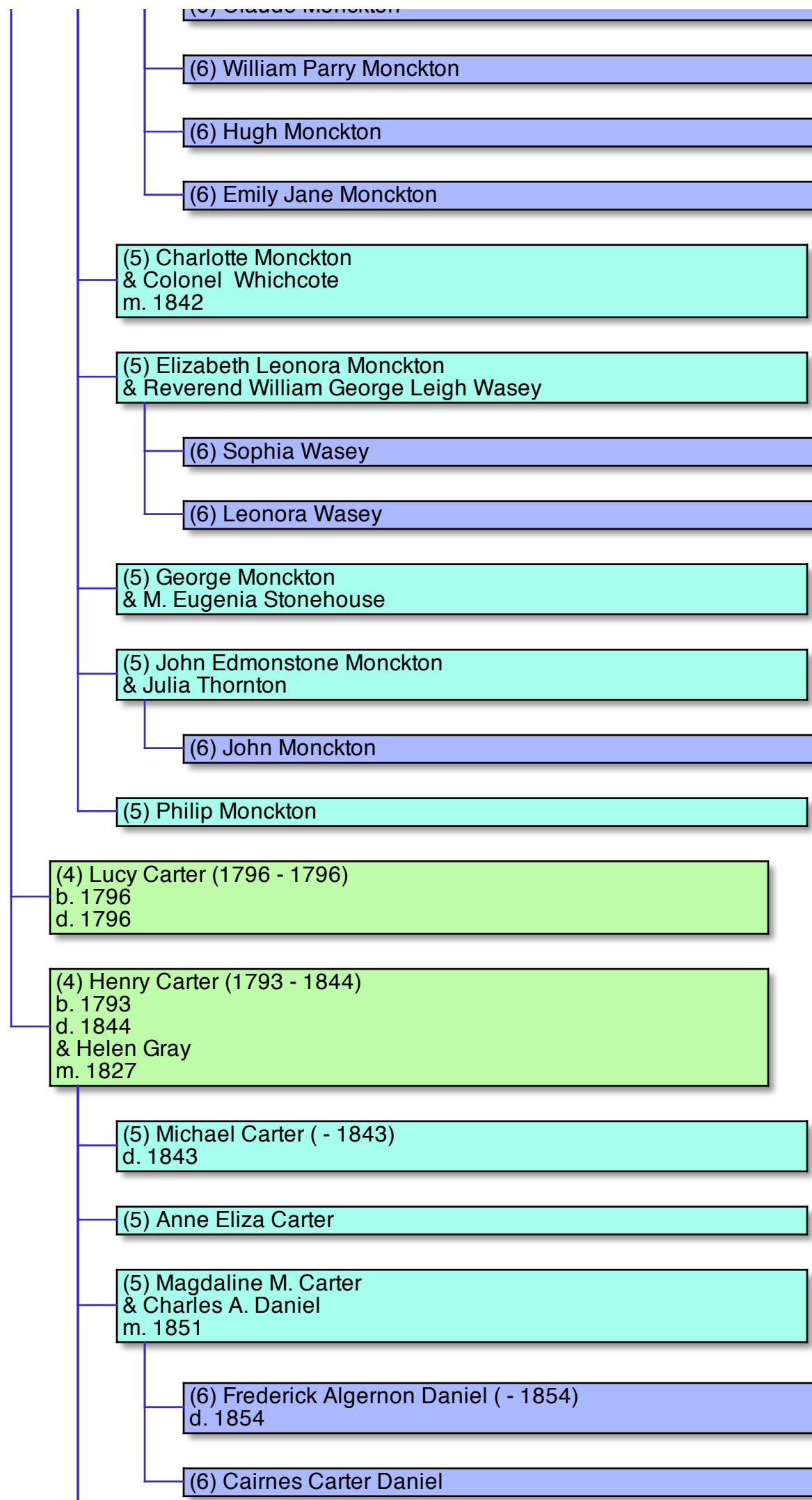

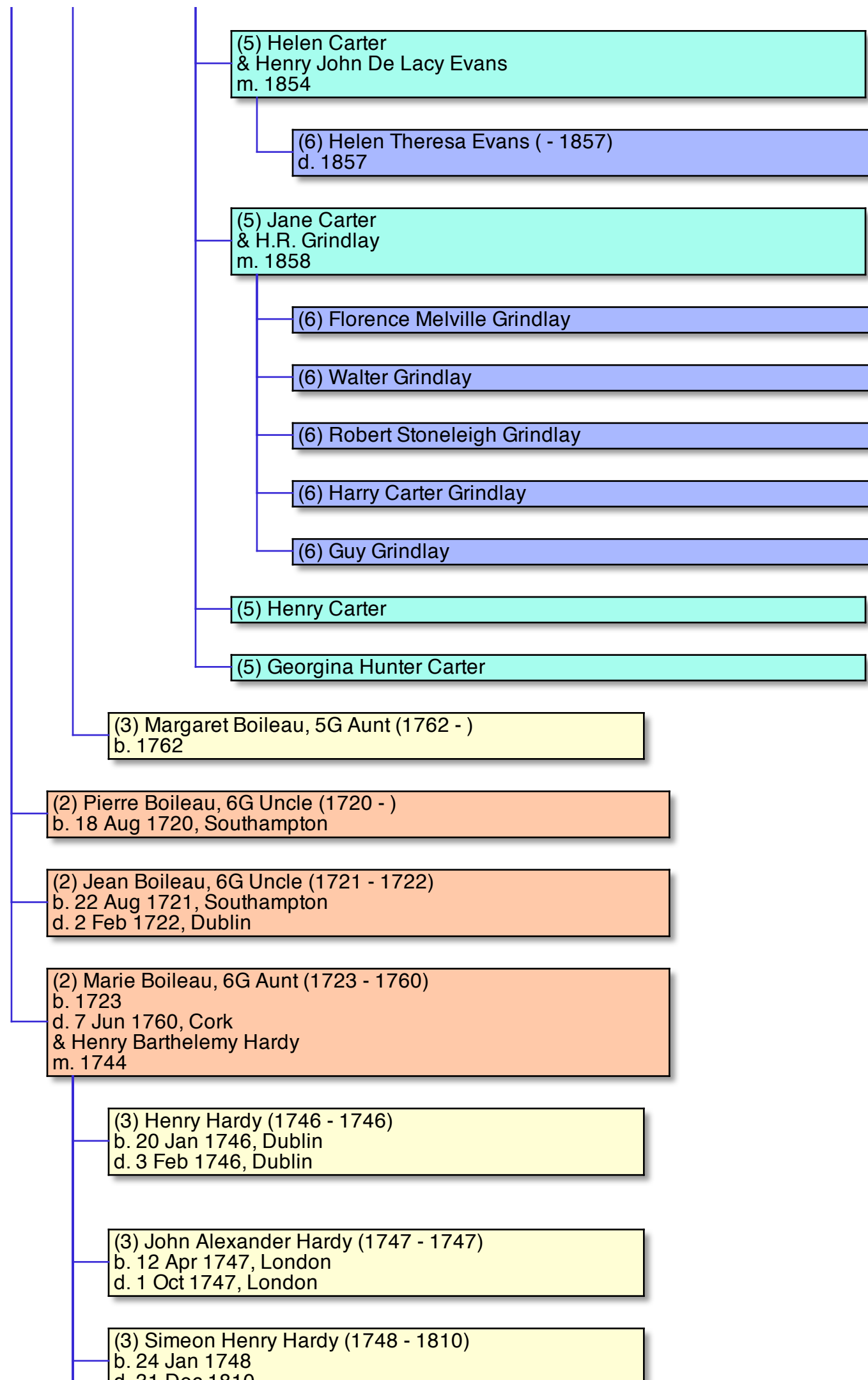

d. 31 Dec 1810

(3) Mary Hardy (1750 - 1783)  
b. 10 Feb 1750, Dublin  
d. 3 Mar 1783, Dublin

(3) Charlotte Louisa Hardy (1751 - 1751)  
b. 10 May 1751, Dublin  
d. 27 Sep 1751, Dublin

(3) Martha Magdaleine Hardy (1752 - 1752)  
b. 20 Jun 1752, Dublin  
d. 27 Nov 1752, Dublin

(3) John Hardy (1753 - 1769)  
b. 16 Jul 1753, Dublin  
d. 15 May 1769

(3) Richard Hardy (1754 - 1756)  
b. 21 Oct 1754, Cork  
d. 10 Apr 1756, Cork

(3) Hardy (1756 - 1756)  
b. 25 Sep 1756  
d. 25 Sep 1756

(3) Peter Harmer Hardy (1759 - 1782)  
b. 25 Nov 1759, Cork  
d. Jan 1782, East Indies